

Operation



Reactor® 2 Elite Integrated

Proportioning System

332636H
EN

Electric, Heated, Integrated Plural Component Proportioning System With Integrated Generator. For spraying polyurethane foam and polyurea coatings. For professional use only. Not approved for use in explosive atmospheres or hazardous locations. Not for outdoor use.



Important Safety Instructions. Read all warnings and instructions in this manual. Save these instructions.

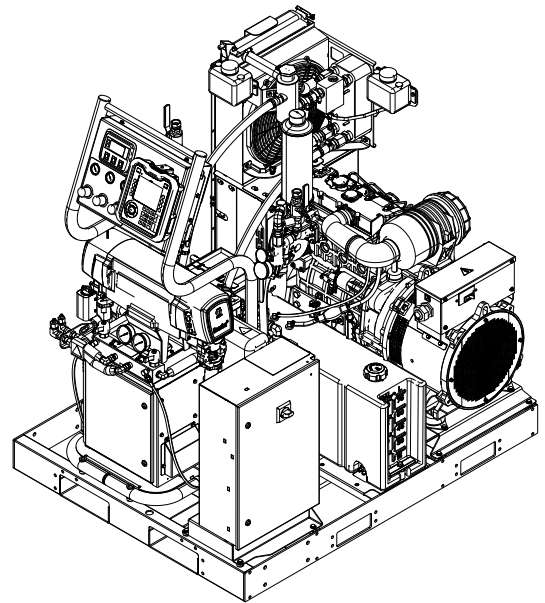

ti21816c







PROVEN QUALITY. LEADING TECHNOLOGY.









Contents





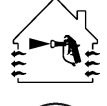

Warnings	3	Advanced Setup Screens	50
Important Isocyanate Information	8	System 1	51
Models	10	System 2	51
Approvals	12	Recipes	51
Accessories	12	Run Mode	53
Supplied Manuals	13	Startup	57
Related Manuals	13	Fluid Circulation	61
Typical Installation, without circulation	14	Circulation Through Reactor	61
Typical Installation, with circulation	15	Circulation Through Gun Manifold	62
Component Identification	16	Jog Mode	62
Generator	18	Spraying	63
Proportioner Control Panel	19	Spray Adjustments	64
Air Compressor	20	Manual Hose Heat Mode	65
Advanced Display Module	21	Shutdown	67
Electrical Enclosure	26	Pressure Relief Procedure	69
Electrical Cabinet	27	Flushing	70
Motor Control Module (MCM)	28	System Errors	71
Engine Control Module	29	Troubleshoot Errors	72
Load Center	30	Clear Alarm	72
Temperature Control Module (TCM) Cable		Maintenance	73
Connections	31	Preventative Maintenance Schedule	73
Circuit Breakers	32	Wetcup	73
Overview	34	Fluid Inlet Strainer Screen	73
Setup	37	Coolant Filter	73
Locate Reactor	37	Grease Circulation Valves	73
Trailer Setup Guidelines	38	ISO Lubrication Level	73
Install Wall (optional)	39	Wiring Connections	73
Connect Battery	41	Dust Protection	73
Add Fuel	41	Coolant Levels	73
General Equipment Guidelines	42	Compressor Maintenance	73
Electrical Connections	42	Air Compressor Oil Level	73
Connect Feed Pumps	42	Clean Heat Sink Fins	74
Breathing Air	42	Engine Maintenance	74
Connect Pressure Relief Lines	43	Fuel Tank	75
Install Fluid Temperature Sensor	43	Flush Inlet Strainer Screen	75
Connect Heated Hose to Proportioner	43	Pump Lubrication System	76
Close gun fluid manifold valves A and		USB Data	77
B	44	USB Logs	77
Connect Whip Hose to Gun Or Gun Fluid		System Configuration Settings	78
Manifold	44	Download Log Files	79
Pressure Check Hose	44	Custom Language File	79
Connect Remote Display Module	44	Upload Procedure	80
Grounding	45	Appendix A: Engine Control Module	81
Supply Wet Cups With Throat Seal Liquid		Dimensions	86
(TSL)	46	Performance Charts	89
Operation	47	Technical Specifications	92
Initial System Setup	47	Graco Extended Warranty for Integrated	
Register and Activate the Graco Insite	48	Reactor® 2 Components	95

Warnings

The following warnings are for the setup, use, grounding, maintenance, and repair of this equipment. The exclamation point symbol alerts you to a general warning and the hazard symbols refer to procedure-specific risks. When these symbols appear in the body of this manual or on warning labels, refer back to these Warnings. Product-specific hazard symbols and warnings not covered in this section may appear throughout the body of this manual where applicable.

 <h2 style="margin: 0;">WARNING</h2>	
 	<p>ELECTRIC SHOCK HAZARD</p> <p>This equipment must be grounded. Improper grounding, setup, or usage of the system can cause electric shock.</p> <ul style="list-style-type: none"> • Turn off and disconnect power at main switch before disconnecting any cables and before servicing equipment. • Connect only to grounded power source. • All electrical wiring must be done by a qualified electrician and comply with all local codes and regulations.
	<p>TOXIC FLUID OR FUMES</p> <p>Toxic fluids or fumes can cause serious injury or death if splashed in the eyes or on skin, inhaled or swallowed.</p> <ul style="list-style-type: none"> • Read Safety Data Sheet (SDS) for handling instructions and to know the specific hazards of the fluids you are using, including the effects of long-term exposure. • When spraying, servicing equipment, or when in the work area, always keep work area well ventilated and always wear appropriate personal protective equipment. See Personal Protective Equipment warnings in this manual. • Store hazardous fluid in approved containers, and dispose of it according to applicable guidelines.
	<p>CARBON MONOXIDE HAZARD</p> <p>Exhaust contains poisonous carbon monoxide, which is colorless and odorless. Breathing carbon monoxide can cause death.</p> <ul style="list-style-type: none"> • Do not operate in an enclosed area.
	<p>PERSONAL PROTECTIVE EQUIPMENT</p> <p>Always wear appropriate personal protective equipment and cover all skin when spraying, servicing equipment, or when in the work area. Protective equipment helps prevent serious injury, including long-term exposure; inhalation of toxic fumes, mists or vapors; allergic reaction; burns; eye injury and hearing loss. This protective equipment includes but is not limited to:</p> <ul style="list-style-type: none"> • A properly fitting respirator, which may include a supplied-air respirator, chemically impermeable gloves, protective clothing and foot coverings as recommended by the fluid manufacturer and local regulatory authority. • Protective eyewear and hearing protection.

 <h1 style="margin: 0;">WARNING</h1>	
  	<p>SKIN INJECTION HAZARD</p> <p>High-pressure fluid from gun, hose leaks, or ruptured components will pierce skin. This may look like just a cut, but it is a serious injury that can result in amputation. Get immediate surgical treatment.</p> <ul style="list-style-type: none"> • Do not spray without tip guard and trigger guard installed. • Engage trigger lock when not spraying. • Do not point gun at anyone or at any part of the body. • Do not put your hand over the spray tip. • Do not stop or deflect leaks with your hand, body, glove, or rag. • Follow the Pressure Relief Procedure when you stop spraying and before cleaning, checking, or servicing equipment. • Tighten all fluid connections before operating the equipment. • Check hoses and couplings daily. Replace worn or damaged parts immediately.
   	<p>FIRE AND EXPLOSION HAZARD</p> <p>Flammable fumes, such as solvent and paint fumes, in work area can ignite or explode. To help prevent fire and explosion:</p> <ul style="list-style-type: none"> • Use equipment only in well ventilated area. • Eliminate all ignition sources; such as pilot lights, cigarettes, portable electric lamps, and plastic drop cloths (potential static arc). • Keep work area free of debris, including solvent, rags and gasoline. • Do not plug or unplug power cords, or turn power or light switches on or off when flammable fumes are present. • Ground all equipment in the work area. See Grounding instructions. • Use only grounded hoses. • Hold gun firmly to side of grounded pail when triggering into pail. Do not use pail liners unless they are antistatic or conductive. • Stop operation immediately if static sparking occurs or you feel a shock. Do not use equipment until you identify and correct the problem. • Keep a working fire extinguisher in the work area.

 <h1 style="margin: 0;">WARNING</h1>	
  	<p>THERMAL EXPANSION HAZARD</p> <p>Fluids subjected to heat in confined spaces, including hoses, can create a rapid rise in pressure due to the thermal expansion. Over-pressurization can result in equipment rupture and serious injury.</p> <ul style="list-style-type: none"> • Open a valve to relieve the fluid expansion during heating. • Replace hoses proactively at regular intervals based on your operating conditions.
	<p>PRESSURIZED ALUMINUM PARTS HAZARD</p> <p>Use of fluids that are incompatible with aluminum in pressurized equipment can cause serious chemical reaction and equipment rupture. Failure to follow this warning can result in death, serious injury, or property damage.</p> <ul style="list-style-type: none"> • Do not use 1,1,1-trichloroethane, methylene chloride, other halogenated hydrocarbon solvents or fluids containing such solvents. • Many other fluids may contain chemicals that can react with aluminum. Contact your material supplier for compatibility.
 	<p>PLASTIC PARTS CLEANING SOLVENT HAZARD</p> <p>Many solvents can degrade plastic parts and cause them to fail, which could cause serious injury or property damage.</p> <ul style="list-style-type: none"> • Use only compatible water-based solvents to clean plastic structural or pressure-containing parts. • See Technical Data in this and all other equipment instruction manuals. Read fluid and solvent manufacturer's MSDSs and recommendations.



WARNING



EQUIPMENT MISUSE HAZARD

Misuse can cause death or serious injury.



- Do not operate the unit when fatigued or under the influence of drugs or alcohol.
- Do not exceed the maximum working pressure or temperature rating of the lowest rated system component. See **Technical Data** in all equipment manuals.
- Use fluids and solvents that are compatible with equipment wetted parts. See Technical Data in all equipment manuals. Read fluid and solvent manufacturer's warnings. For complete information about your material, request MSDS from distributor or retailer.
- Do not leave the work area while equipment is energized or under pressure.
- Turn off all equipment and follow the **Pressure Relief Procedure** when equipment is not in use.
- Check equipment daily. Repair or replace worn or damaged parts immediately with genuine manufacturer's replacement parts only.
- Do not alter or modify equipment. Alterations or modifications may void agency approvals and create safety hazards.
- Make sure all equipment is rated and approved for the environment in which you are using it.
- Use equipment only for its intended purpose. Call your distributor for information.
- Route hoses and cables away from traffic areas, sharp edges, moving parts, and hot surfaces.
- Do not kink or over bend hoses or use hoses to pull equipment.
- Keep children and animals away from work area.
- Comply with all applicable safety regulations.



BATTERY HAZARD

The battery may leak, explode, cause burns, or cause an explosion if mishandled.

- Only use the battery type specified for use with the equipment. See **Technical Data**.
- Battery maintenance must only be performed or supervised by personnel knowledgeable of batteries and the required precautions. Keep unauthorized personnel away from battery.
- When replacing the battery, use the same lead-acid automotive battery, with 800 CCA minimum, specified for use with the equipment. See **Technical Data**.
- Do not dispose of battery in fire. The battery is capable of exploding.
- Follow local ordinances and/or regulations for disposal.
- Do not open or mutilate the battery. Released electrolyte has been known to be harmful to the skin and eyes and to be toxic.
- Remove watches, rings, or other metal objects.
- Only use tools with insulated handles. Do not lay tools or metal parts on top of battery.





MOVING PARTS HAZARD

Moving parts can pinch, cut or amputate fingers and other body parts.



- Keep clear of moving parts.
- Do not operate equipment with protective guards or covers removed.
- Pressurized equipment can start without warning. Before checking, moving, or servicing equipment, follow the **Pressure Relief Procedure** and disconnect all power sources.

 WARNING	
	<p>ENTANGLEMENT HAZARD</p> <p>Rotating parts can cause serious injury.</p> <ul style="list-style-type: none"> • Keep clear of moving parts. • Do not operate equipment with protective guards or covers removed. • Do not wear loose clothing, jewelry or long hair while operating equipment. • Equipment can start without warning. Before checking, moving, or servicing equipment, follow the Pressure Relief Procedure and disconnect all power sources.
	<p>BURN HAZARD</p> <p>Equipment surfaces and fluid that is heated can become very hot during operation. To avoid severe burns:</p> <ul style="list-style-type: none"> • Do not touch hot fluid or equipment.
	<p>CALIFORNIA PROPOSITION 65</p> <p>The engine exhaust from this product contains a chemical known to the State of California to cause cancer, birth defects or other reproductive harm.</p>

Important Isocyanate Information

Isocyanates (ISO) are catalysts used in two component materials.

Isocyanate Conditions

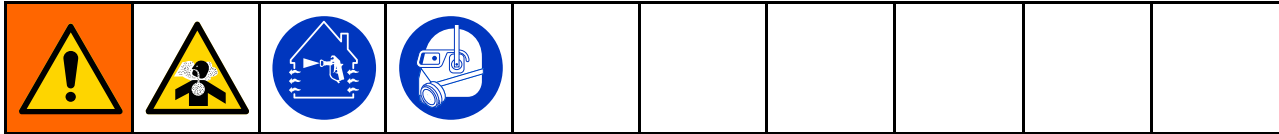



Spraying or dispensing fluids that contain isocyanates creates potentially harmful mists, vapors, and atomized particulates.



- Read and understand the fluid manufacturer's warnings and Safety Data Sheet (SDS) to know specific hazards and precautions related to isocyanates.
- Use of isocyanates involves potentially hazardous procedures. Do not spray with this equipment unless you are trained, qualified, and have read and understood the information in this manual and in the fluid manufacturer's application instructions and SDS.
- Use of incorrectly maintained or mis-adjusted equipment may result in improperly cured material, which could cause off gassing and offensive odors. Equipment must be carefully maintained and adjusted according to instructions in the manual.
- To prevent inhalation of isocyanate mists, vapors and atomized particulates, everyone in the work area must wear appropriate respiratory protection. Always wear a properly fitting respirator, which may include a supplied-air respirator. Ventilate the work area according to instructions in the fluid manufacturer's SDS.
- Avoid all skin contact with isocyanates. Everyone in the work area must wear chemically impermeable gloves, protective clothing and foot coverings as recommended by the fluid manufacturer and local regulatory authority. Follow all fluid manufacturer recommendations, including those regarding handling of contaminated clothing. After spraying, wash hands and face before eating or drinking.
- Hazard from exposure to isocyanates continues after spraying. Anyone without appropriate personal protective equipment must stay out of the work area during application and after application for the time period specified by the fluid manufacturer. Generally this time period is at least 24 hours.
- Warn others who may enter work area of hazard from exposure to isocyanates. Follow the recommendations of the fluid manufacturer and local regulatory authority. Posting a placard such as the following outside the work area is recommended:



Material Self-Ignition

				
Some materials may become self-igniting if applied too thick. Read material manufacturer's warnings and SDS.				

Keep Components A and B Separate

				
Cross-contamination can result in cured material in fluid lines which could cause serious injury or damage to equipment. To prevent cross-contamination:				
<ul style="list-style-type: none"> • Never interchange component A and component B wetted parts. • Never use solvent on one side if it has been contaminated from the other side. 				

Changing Materials

NOTICE				
Changing the material types used in your equipment requires special attention to avoid equipment damage and downtime.				
<ul style="list-style-type: none"> • When changing materials, flush the equipment multiple times to ensure it is thoroughly clean. • Always clean the fluid inlet strainers after flushing. • Check with your material manufacturer for chemical compatibility. • When changing between epoxies and urethanes or polyureas, disassemble and clean all fluid components and change hoses. Epoxies often have amines on the B (hardener) side. Polyureas often have amines on the B (resin) side. 				

Moisture Sensitivity of Isocyanates

Exposure to moisture (such as humidity) will cause ISO to partially cure, forming small, hard, abrasive crystals that become suspended in the fluid. Eventually a film will form on the surface and the ISO will begin to gel, increasing in viscosity.

NOTICE				
Partially cured ISO will reduce performance and the life of all wetted parts.				
<ul style="list-style-type: none"> • Always use a sealed container with a desiccant dryer in the vent, or a nitrogen atmosphere. Never store ISO in an open container. • Keep the ISO pump wet cup or reservoir (if installed) filled with appropriate lubricant. The lubricant creates a barrier between the ISO and the atmosphere. • Use only moisture-proof hoses compatible with ISO. • Never use reclaimed solvents, which may contain moisture. Always keep solvent containers closed when not in use. • Always lubricate threaded parts with an appropriate lubricant when reassembling. 				

NOTE: The amount of film formation and rate of crystallization varies depending on the blend of ISO, the humidity, and the temperature.

Foam Resins with 245 fa Blowing Agents

Some foam blowing agents will froth at temperatures above 90°F (33°C) when not under pressure, especially if agitated. To reduce frothing, minimize preheating in a circulation system.

Models

Reactor 2 E-30i Elite

All base systems include fluid inlet pressure and temperature sensors and Graco InSite™. For part numbers, see [Accessories, page 12](#).

Model	No Air Compressor/Dryer		◆With Air Compressor/Dryer	
	E-30i	E-30i with heat	E-30i	E-30i with heat
Base Machine●	272079	272080	272089	272090
Maximum Fluid Working Pressure psi (MPa, bar)	2000 (13.8, 138)	2000 (13.8, 138)	2000 (13.8, 138)	2000 (13.8, 138)
Approximate Output per Cycle (A+B) gal. (liter)	0.0272 (0.1034)	0.0272 (0.1034)	0.0272 (0.1034)	0.0272 (0.1034)
Max Flow Rate lb/min (kg/min)	30 (13.5)	30 (13.5)	30 (13.5)	30 (13.5)
Total System Load † (Watts)	7,400	11,600	13,500	17,700
Voltage (phase)	240 VAC (1)	240 VAC (1)	240 VAC (1)	240 VAC (1)
Available Auxiliary Current at Volts, 60 Hz★	52 Amps (240)	35 Amps (240)	22 Amps (240) 9 Amps (120)	5 Amps (240) 9 Amps (120)

Fusion AP Package ✖ (Gun Part No.)	AP2079 (246102)	AH2079 (246102)	AP2080 (246102)	AH2080 (246102)	AP2089 (246102)	AH2089 (246102)	AP2090 (246102)	AH2090 (246102)
Fusion CS Package ✖ (Gun Part No.)	CS2079 (CS02RD)	CH2079 (CS02RD)	CS2080 (CS02RD)	CH2080 (CS02RD)	CS2089 (CS02RD)	CH2089 (CS02RD)	CS2090 (CS02RD)	CH2090 (CS02RD)
Probler P2 Package ✖ (Gun Part No.)	P22079 (GCP2R2)	PH2079 (GCP2R2)	P22080 (GCP2R2)	PH2080 (GCP2R2)	P22089 (GCP2R2)	PH2089 (GCP2R2)	P22090 (GCP2R2)	PH2090 (GCP2R2)
Heated Hose 50 ft (15 m) 24Y240 (Xtreme- Wrap)	24Y240	24Y240	24Y240	24Y240	24Y240	24Y240	24Y240	24Y240
	Qty: 1	Qty: 5	Qty: 1	Qty: 5	Qty: 1	Qty: 5	Qty: 1	Qty: 5
Heated Whip Hose 10 ft (3 m)	246050		246050		246050		246050	

† Total system watts used by system, based on maximum heated hose length of 310 ft (94.5 m) for each unit.

* Full load amps available for auxiliary equipment when all bare-system components are operating at maximum capabilities. Available auxiliary current is based on 310 ft (94.5 m) of heated hose. An additional 3.0 amps (240 VAC) of auxiliary current is available for each 50 ft (15.2 m) section of heated hose that is not used.

Auxiliary current at 120 VAC is available on CB08, line 1 (circuit breaker pin 2), line 2 current at 120 VAC is used by the air dryer (circuit breaker pin 4).

★ Available auxiliary current will be less when the engine is de-rated for site altitude. Reduce the Available Auxiliary Current in the chart by 2.5 Amps (240 VAC) per 1000 ft (300 m) elevation increments. If the available auxiliary current is less than zero, the system configuration may not support the full load at that altitude.

◆ Includes Complete Air Compressor/Dryer Kit 24U176.

Refer to [Circuit Breaker Configuration Options, page 33](#).

● See [Approvals, page 12](#).

✖ Packages include gun, heated hose, and whip hose.

Reactor 2 E-XP2i Elite

All base systems include fluid inlet pressure and temperature sensors and Graco InSite™. For part numbers, see [Accessories, page 12](#).

Model	No Air Compressor/Dryer	◆With Air Compressor/Dryer
	E-XP2i with heat	E-XP2i with heat
Base Machine●	272081	272091
Maximum Fluid Working Pressure psi (MPa, bar)	3500 (24.1, 241)	3500 (24.1, 241)
Approximate Output per Cycle (A+B) gal. (liter)	0.0203 (0.0771)	0.0203 (0.0771)
Max Flow Rate gal/min (l/min)	2.0 (7.6)	2.0 (7.6)
Total System Load † (Watts)	11,600	17,700
Voltage (phase)	240 VAC (1)	240 VAC (1)
Available Auxiliary Current at Volts, 60 Hz★	35 Amps (240)	5 Amps (240) 9 Amps (120)
Fusion AP Package ✘ (Gun Part No.)		
	AP2081 (246100)	AP2091 (246100)
Probler P2 Package ✘ (Gun Part No.)		
	P22081 (GCP2R0)	P22091 (GCP2R0)
Heated Hose 50 ft (15 m)	24Y241 Xtreme-Wrap	24Y241 Xtreme-Wrap
Heated Whip Hose 10 ft (3 m)	246055	246055

† Total system watts used by system, based on maximum heated hose length of 310 ft (94.5 m) for each unit.

* Full load amps available for auxiliary equipment when all bare-system components are operating at maximum capabilities. Available auxiliary current is based on 310 ft (94.5 m) of heated hose. An additional 3.0 amps (240 VAC) of auxiliary current is available for each 50 ft (15.2 m) section of heated hose that is not used.

Auxiliary current at 120 VAC is available on line 1 (circuit breaker pin 2), line 2 current at 120 VAC is used by the air dryer (circuit breaker pin 4).

★ Available auxiliary current will be less when the engine is de-rated for site altitude. Reduce the Available Auxiliary Current in the chart by 2.5 Amps (240 VAC) per 1000 ft (300 m) elevation increments. If the available auxiliary current is less than zero, the system configuration may not support the full load at that altitude.

◆ Includes Complete Air Compressor/Dryer Kit 24U176.



Refer to [Circuit Breaker Configuration Options, page 33](#).

● See [Approvals, page 12](#).

✘ Packages include gun, heated hose, and whip hose.

Approvals

Intertek approvals apply to proportioning systems without hoses.

Model	Proportioning System Approvals:
272079 272080 272081 272089 272090 272091	 Intertek 9902471 Conforms to UL Std. 499 Certified to CAN/CSA Std. C22.2 No. 88 

Note

Heated hoses provided with a system or sold individually are not approved by Intertek.

Accessories

Kit Number	Description
15M483	Remote Display Module Protective Covers (10 pack)
15V551	ADM Protective Covers (10 pack)
24K207	Fluid Temperature Sensor (FTS) with RTD
24K333	Fuel Line and Cable Extension Kit
24K336	Hose Rack
24K337	Light Tower Kit
24L911	Pallet Support Kit
24M174	Drum Level Sticks
24U174	Remote Display Module Kit
24U176	Complete Air Compressor Kit
24U177	Feed Pump Shutdown Kit
24U181	Booster Heat Upgrade Kit
Cables	
121006	150 ft (45 m) cable (for remote display module)
24N365	RTD Test Cables (to aide resistance measurements)
24N449	50 ft (15 m) CAN cable (for remote display module)

Supplied Manuals

The following manuals are shipped with the Reactor. Refer to these manuals for detailed equipment information.

Manuals are also available at www.graco.com.

Manual	Description
332636	Reactor 2 Elite Integrated Proportioning System, Operation
333093	Reactor 2 Elite Integrated Proportioning System, Startup Instructions
333094	Reactor 2 Elite Integrated Proportioning System, Shutdown Instructions
SEBU8311-02	Perkins® Engine, Repair-Parts <i>Access at www.perkins.com. Go to Service and Support/manuals. Select engine family and type code "GN".</i>
-	Mecc Alte Self-Regulating Alternator Series NPE, Repair-Parts <i>Access at www.meccalte.com. Select "meccalte" logo / Download / Instruction Manuals. Select NPE instruction manual on page 5. Go to Support and enter serial number for Parts List and Help Videos.</i> <i>Contact Mecc Alte for warranty and service</i>
ST 15825-00	Air Compressor, Operation/Maintenance & Parts list. <i>Access at www.hydrovaneproducts.com. Go to Warranty & Service tab and select "contact us" to request manuals.</i>
33227482	Refrigerated Air Dryer, Instruction manual Access from Service Department (724) 746-1100 or www.spx.com/en/hankison .

Related Manuals

The following manuals are for accessories used with the Reactor.

Component Manuals in English:

Manuals are available at www.graco.com.

System Manuals	
332637	Reactor 2 Elite Integrated Proportioning System, Repair-Parts
Displacement Pump Manual	
309577	Electric Reactor Displacement Pump, Repair-Parts
Feed System Manuals	
309572	Heated Hose, Instructions-Parts
309852	Circulation and Return Tube Kit, Instructions-Parts
309815	Feed Pump Kits, Instructions-Parts
309827	Feed Pump Air Supply Kit, Instructions-Parts
Spray Gun Manuals	
309550	Fusion™ AP Gun
312666	Fusion™ CS Gun
313213	Probler P2 Gun
Accessory Manuals	
332733	Air Compressor and Air Dryer Kit, Instructions-Parts
3A1905	Feed Pump Shutdown Kit, Instructions-Parts
3A1906	Light Tower Kit, Instructions-Parts
3A1904	Fuel Tank/Battery Move Kit, Instructions-Parts
3A1903	Hose Rack, Instructions-Parts
332738	Booster Heat Retrofit Kit, Instructions-Parts
3A1907	Remote Display Module, Instructions-Parts
3A2574	Pallet Support Kit, Instructions-Parts

Typical Installation, without circulation

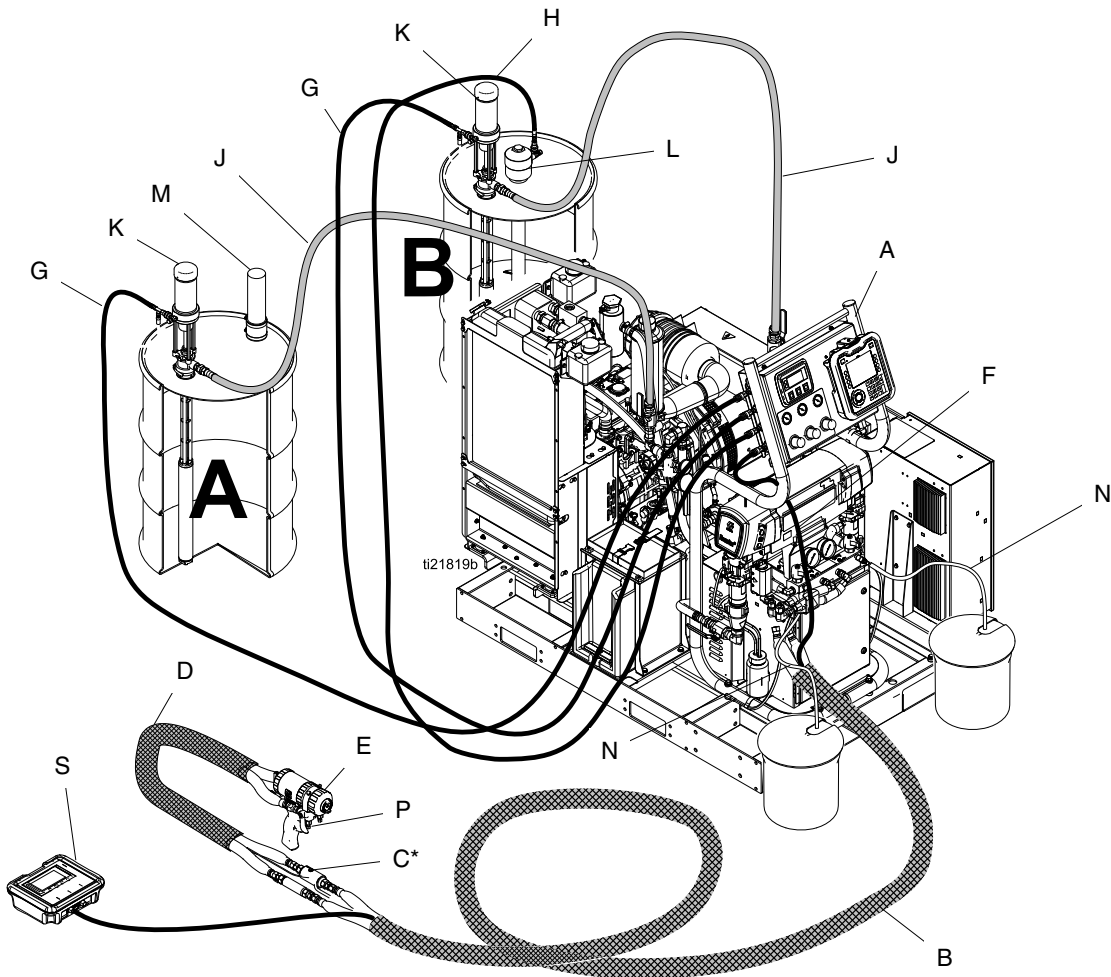

Figure 1

* Shown exposed for clarity. Wrap with tape during operation.

A	Reactor Proportioner	J	Fluid Supply Lines
B	Heated Hose	K	Feed Pumps
C	Fluid Temperature Sensor (FTS)	L	Agitator
D	Heated Whip Hose	M	Desiccant Dryer
E	Fusion Spray Gun	N	Bleed Lines
F	Gun Air Supply Hose	P	Gun Fluid Manifold (part of gun)
G	Feed Pump Air Supply Lines	S	Remote Display Module Kit (optional)
H	Agitator Air Supply Line		

Typical Installation, with circulation

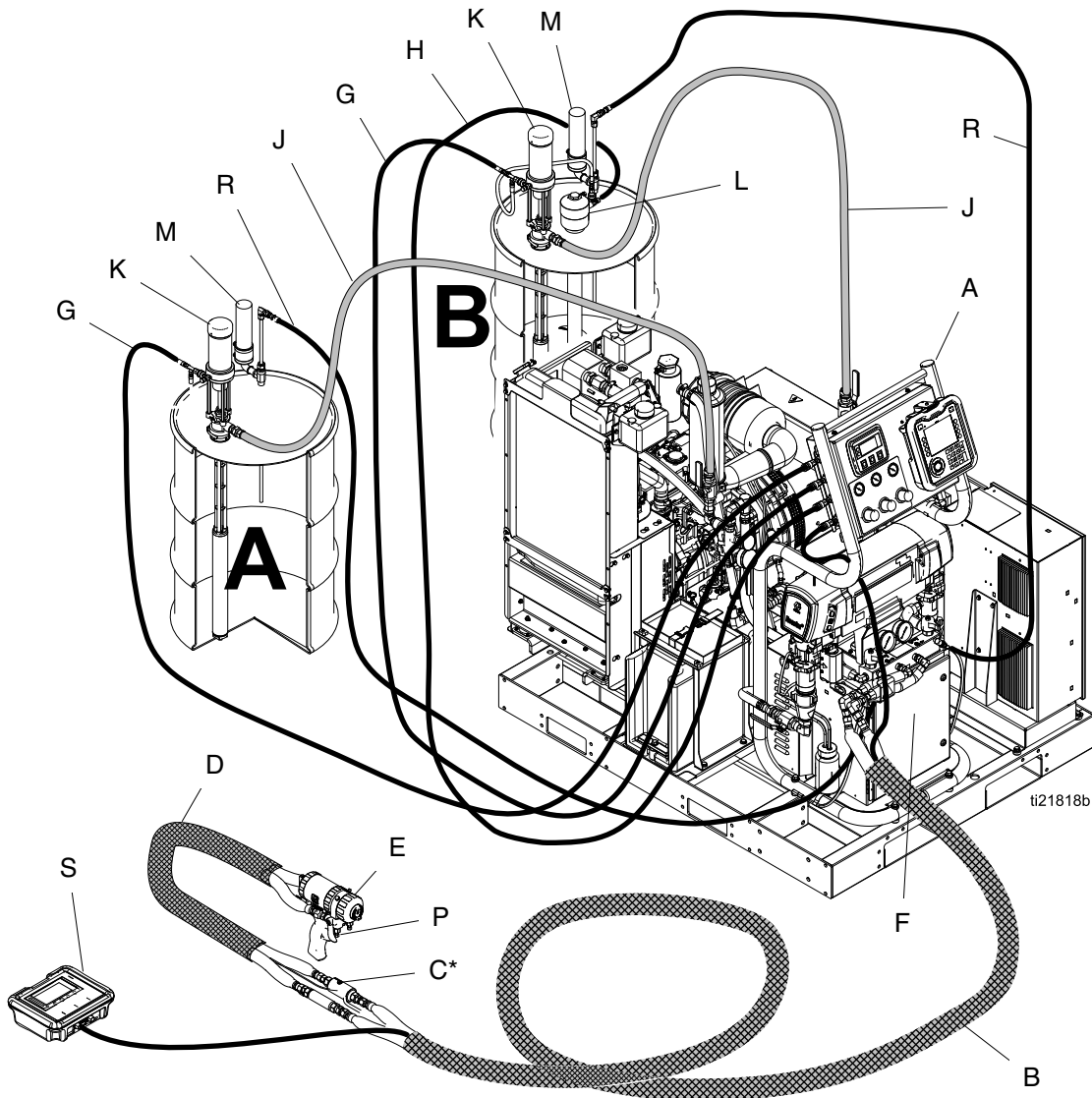

Figure 2

* Shown exposed for clarity. Wrap with tape during operation.

- | | | | |
|---|--------------------------------|---|----------------------------------|
| A | Reactor Proportioner | J | Fluid Supply Lines |
| B | Heated Hose | K | Feed Pumps |
| C | Fluid Temperature Sensor (FTS) | L | Agitator |
| D | Heated Whip Hose | M | Desiccant Dryer |
| E | Fusion Spray Gun | P | Gun Fluid Manifold (part of gun) |
| F | Gun Air Supply Hose | R | Recirculation Lines |
| G | Feed Pump Air Supply Lines | S | Remote Display Module (optional) |
| H | Agitator Air Supply Line | | |

Component Identification

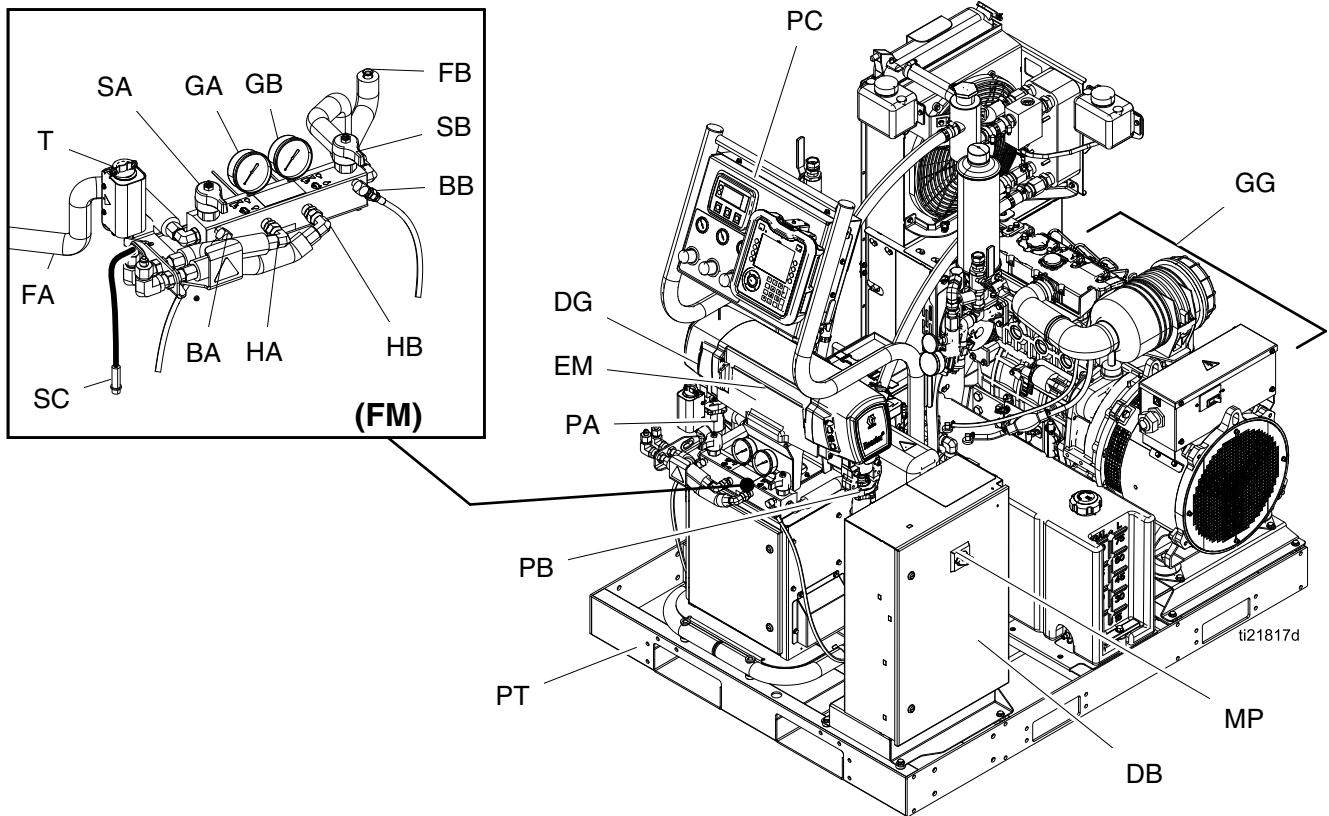

Figure 3 Front View

BA	Component A Pressure Relief Outlet	MP	Main Power Switch
BB	Component B Pressure Relief Outlet	PA	Component A Pump
DG	Drive Gear Housing	PB	Component B Pump (behind Electrical Enclosure)
DB	Electrical Enclosure	PC	Proportioner Control Panel, page 19
EM	Electric Motor	PT	Pallet
FA	Component A Fluid Manifold Inlet	SA	Component A PRESSURE RELIEF/SPRAY Valve
FB	Component B Fluid Manifold Inlet	SB	Component B PRESSURE RELIEF/SPRAY Valve
FM	Reactor Fluid Manifold	SC	Fluid Temperature Sensor (FTS) Cable
GA	Component A Pressure Gauge	TA	Component A Pressure Transducer (behind gauge GA)
GB	Component B Pressure Gauge	TB	Component B Pressure Transducer (behind gauge GB)
GG	Generator, page 18		
HA	Component A Hose Connection		
HB	Component B Hose Connection		
HC	Heated Hose Electrical Connectors		

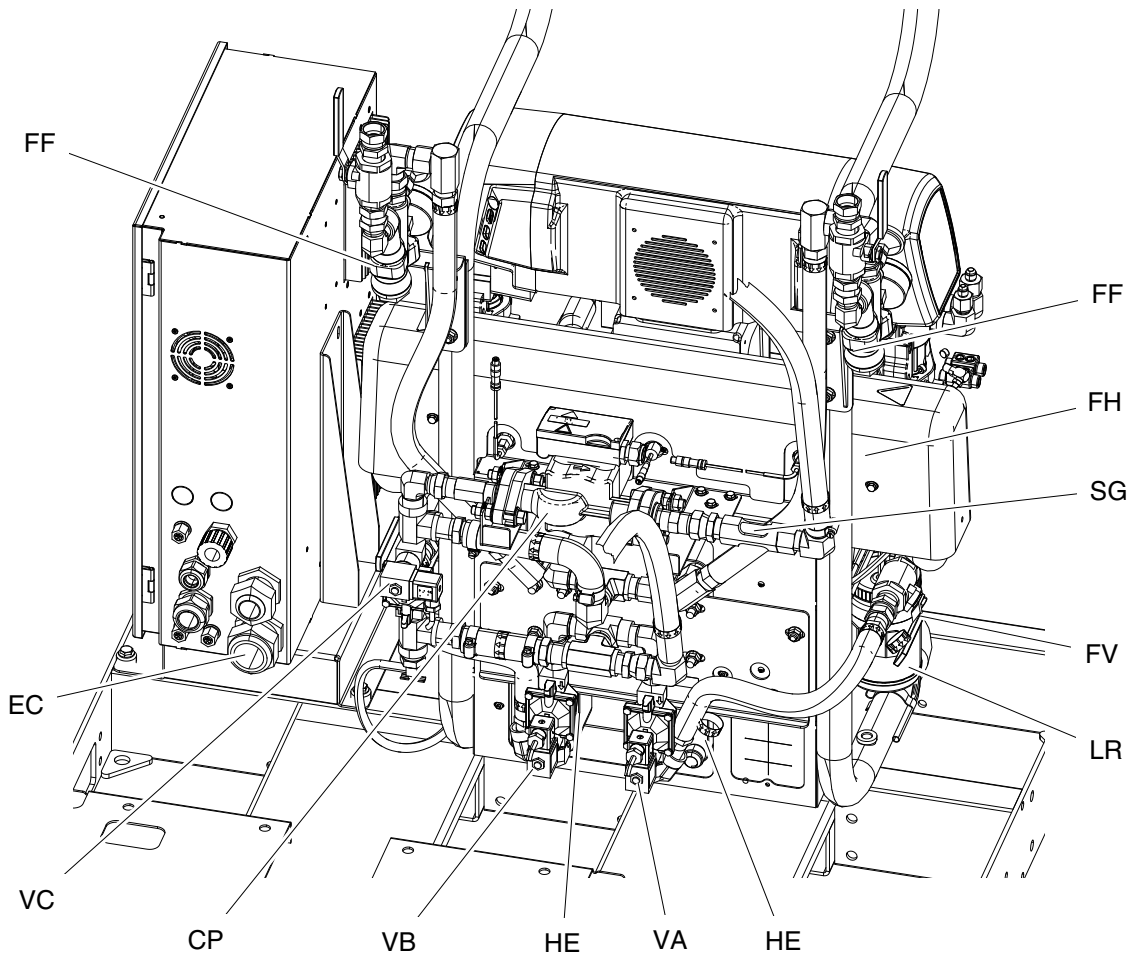

Figure 4 Back View

- CP Circulation Pump
- EC Electrical Cord Strain Relief
- FF Y-strainer (includes pressure gauge, temperature gauge, and pressure/temperature sensor)
- FH Booster Fluid Heater (not included with all models)
- FV Fluid Inlet Valve (A side shown)
- HE Heat Exchangers (heat exchanger coolant loop)

- HM [Temperature Control Module \(TCM\) Cable Connections, page 31](#)
- LR ISO Pump Lubricant Reservoir
- MM [Motor Control Module \(MCM\), page 28](#)
- SG Sight Glass
- VA Component A Control Valve
- VB Component B Control Valve
- VC Bypass Control Valve

Generator

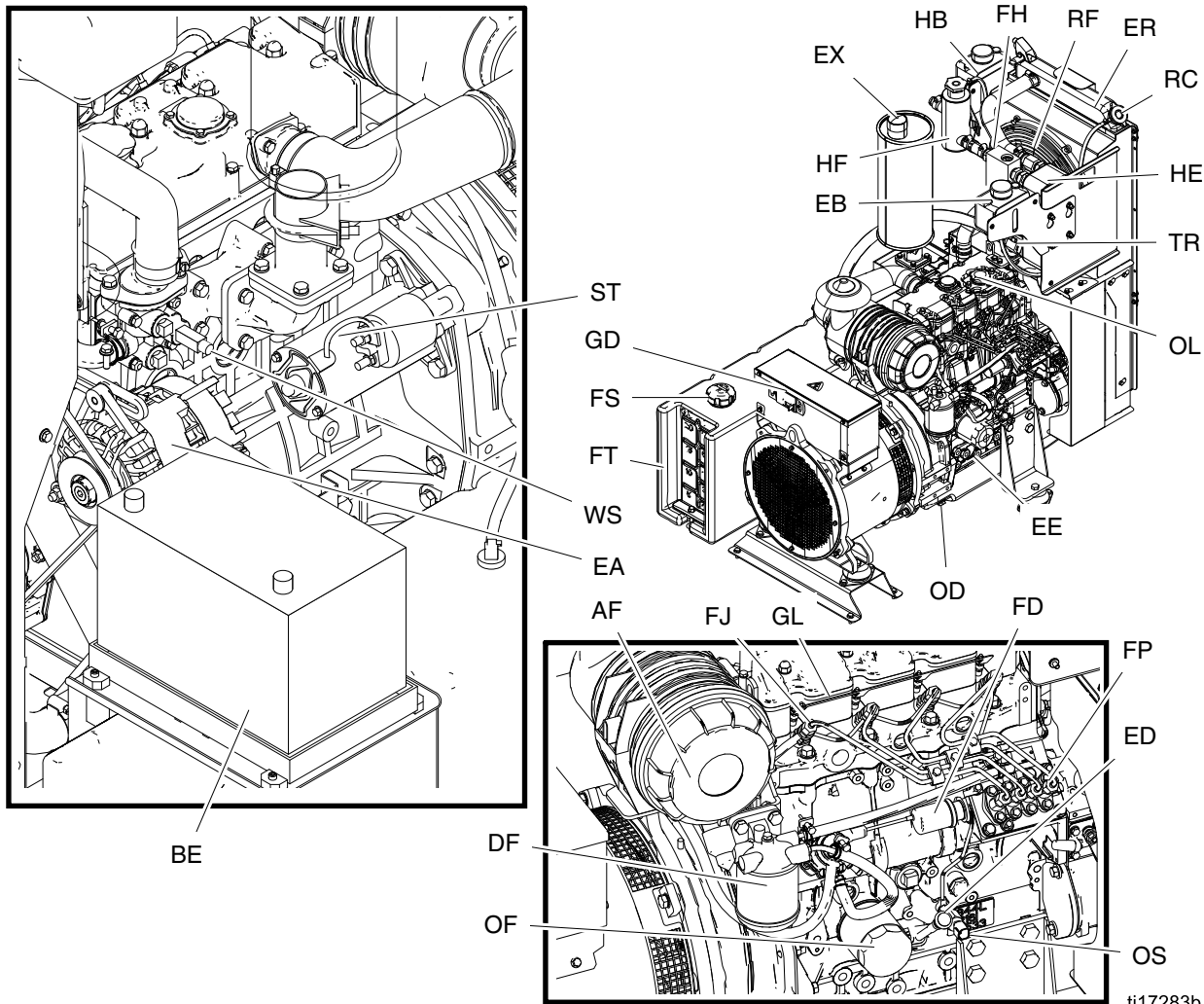

Figure 5

- AF Air Filter
- BE Battery (not supplied)
- DF Diesel Fuel Filter
- EA 12V Charge Alternator
- EB Engine Coolant Expansion Bottle
- EE Engine
- ED Engine Oil Dipstick
- ER Radiator
- EX Exhaust
- FD Fuel Shutoff Solenoid
- FH Filter Housing
- FJ Fuel Injector
- FP Fuel Pump
- FS Diesel Fuel Fill Cap

- FT Diesel Fuel Tank
- GD Generator Power Distribution Box
- GL Glow Plugs
- HB Heat Exchanger Coolant Expansion Bottle
- HE Heat Exchanger
- HF Heat Exchanger Coolant Fill Bottle
- OD Oil Drain
- OF Oil Filter
- OL Oil Fill
- OS Oil Pressure Switch
- RC Engine Coolant Radiator Cap
- RF Radiator Fan
- ST Starter
- TR Coolant Temperature Sensor
- WS Over-Temperature Switch

ti17283b

Proportioner Control Panel

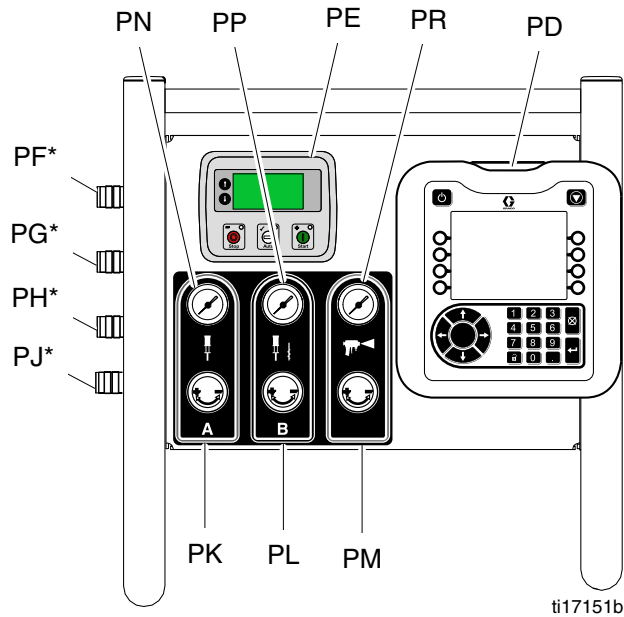

- PD [Advanced Display Module \(ADM\), page 21](#)
 - PE [Engine Control Module, page 29](#)
 - PF* Component A Feed Pump Air Outlet
 - PG* Component B Feed Pump Air Outlet
 - PH* Agitator Air Outlet
 - PJ* Gun Air Outlet
 - PK Component A Feed Pump Air Regulator
 - PL Component B Feed Pump and Agitator Air Regulator
 - PM Gun Air Regulator
 - PN Component A Feed Pump Pressure Gauge
 - PP Component B Feed Pump and Agitator Pressure Gauge
 - PR Gun Pressure Gauge
- * Not for breathing air use.

Figure 6

Component Identification

Air Compressor

Select models are supplied with an air compressor and air dryer.

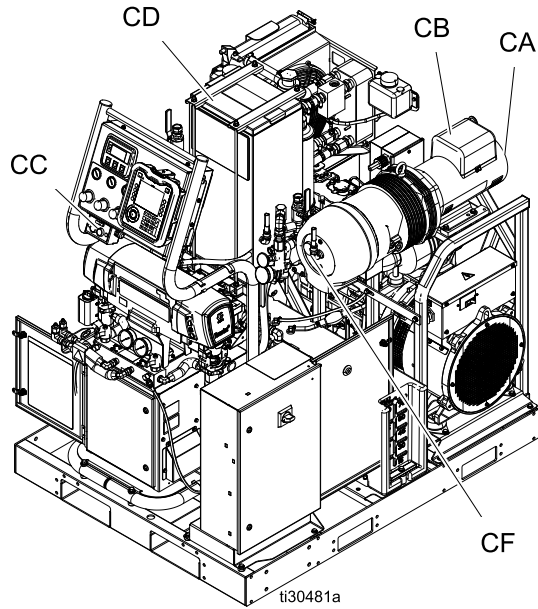

- CA Air Compressor
- CB Power Box
- CC Air Compressor and Dryer On/Off Switch
- CD Refrigerated Air Dryer
- CE Air Dryer Drain Tube (bottom of refrigerated air dryer; not shown)
- CF Air Compressor Pressure Gauge

Figure 7

Advanced Display Module

The ADM display shows graphical and text information related to setup and spray operations.

For detail on the display and individual screens, see [Run Mode, page 53](#), or [Setup Mode](#).

Use the USB port on the ADM to download or upload data. For more information about the USB data, see [USB Data, page 77](#).

NOTICE







To prevent damage to the softkey buttons, do not press buttons with sharp objects such as pens, plastic cards, or fingernails.

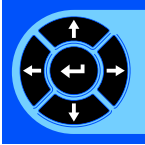

ti22631a

Figure 8 Front View

Table 1 : ADM Keys and Indicators

Key	Function
 <p>Startup/Shutdown Key and Indicator</p>	Press to startup or shutdown the system.
 <p>Stop</p>	Press to stop all proportioner processes. This is not a safety or emergency stop.
 <p>Soft Keys</p>	Press to select the specific screen or operation shown on the display directly next to each key.
 <p>Navigation Keys</p>	<ul style="list-style-type: none"> • <i>Left/Right Arrows:</i> Use to move from screen to screen. • <i>Up/Down Arrows:</i> Use to move among fields on a screen, items on a dropdown menu, or multiple screens within a function.
<p>Numeric Keypad</p>	Use to input values.
 <p>Cancel</p>	Use to cancel a data entry field.
 <p>Setup</p>	Press to enter or exit Setup mode.
 <p>Enter</p>	Press to choose a field to update, to make a selection, to save a selection or value, to enter a screen, or to acknowledge an event.

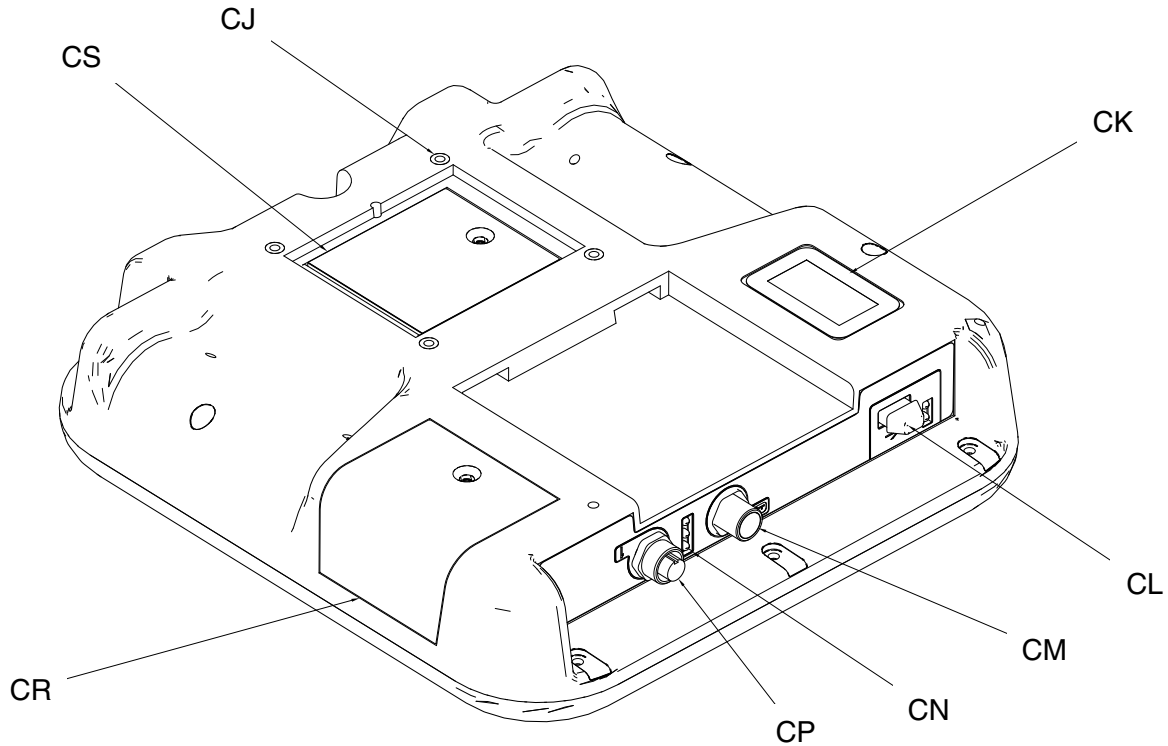



Figure 9 Back View

CJ	Flat Panel Mount (VESA 100)
CK	Model and Serial Number
CL	USB Port and Status LEDs
CM	CAN Cable Connection

CN	Module Status LEDs
CP	Accessory Cable Connection
CR	Token Access Cover
CS	Battery Access Cover

Table 2 ADM LED Status Descriptions

LED	Conditions	Description
System Status 	Green Solid	Run Mode, System On
	Green Flashing	Setup Mode, System On
	Yellow Solid	Run Mode, System Off
	Yellow Flashing	Setup Mode, System Off
USB Status (CL)	Green Flashing	Data recording in progress
	Yellow Solid	Downloading information to USB
	Green and Yellow Flashing	ADM is busy, USB cannot transfer information when in this mode
ADM Status (CN)	Green Solid	Power applied to module
	Yellow Solid	Active Communication
	Red Steady Flashing	Software upload from token in progress
	Red Random Flashing or Solid	Module error exists

ADM Display Details

Power Up Screen

The following screen appears when the ADM is powered up. It remains on while the ADM runs through initialization and establishes communication with other modules in the system.



Menu Bar

The menu bar appears at the top of each screen. (The following image is only an example.)



Date and Time

The date and time are always displayed in one of the following formats. The time is always displayed as a 24-hour clock.

- DD/MM/YY HH:MM
- YY/MM/DD HH:MM
- MM/DD/YY HH:MM

Arrows

The left and right arrows indicate screen navigation.

Screen Menu

The screen menu indicates the currently active screen, which is highlighted. It also indicates the associated screens that are available by scrolling left and right.

System Mode

The current system mode is displayed at the lower left of the menu bar.

Alarm/Deviation

The current system error is displayed in the middle of the menu bar. There are four possibilities:

Icon	Function
No Icon	No information or no error has occurred
	Advisory
	Deviation
	Alarm

Status

The current system status is displayed at the lower right of the menu bar.

Navigating the Screens

There are two sets of screens:

- The Run screens control spraying operations and display system status and data.
- The Setup screens control system parameters and advanced features.

Press on any Run screen to enter the Setup screens. If the system has a password lock, the Password screen displays. If the system is not locked (password is set to 0000), System Screen 1 displays.

Press on any Setup screen to return to the Home screen.

Press the Enter soft key to activate the editing function on any screen.









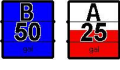

Press the Exit soft key to exit any screen.

Use the other softkeys to select the function adjacent to them.

Icons





















Screen Icons

These are frequently used icons on the screens. The following descriptions explain what each icon represents.

Icon	Description
	Component A
	Component B
	Estimated Supply Material
	Hose Temperature
	Jog Mode Speed
	Engine Coolant Temperature
	Pressure
	Cycle Counter (press and hold)
	Advisory. See System Errors, page 71 for more information.
	Deviation. See System Errors, page 71 for more information
	Alarm. See System Errors, page 71 for more information

Softkey Icons

The following icons appear in the ADM, directly to the left or right of the soft key which activates that operation.

Icon	Function
	Start Proportioner
	Start and Stop Proportioner in Jog Mode
	Stop Proportioner
	Turn on specified heat zone.
	Park component A pump
	Enter Jog Mode. See Jog Mode, page 62
	Reset Cycle Counter (press and hold)
	Select Recipe
	Search
	Move Cursor Left One Character
	Move Cursor Right One Character
	Toggle between upper-case, lower-case, and numbers and special characters.
	Backspace
	Cancel
	Clear
	Troubleshoot Selected Error
	Increase value
	Decrease value
	Next screen
	Previous screen
	Return to first screen

Electrical Enclosure

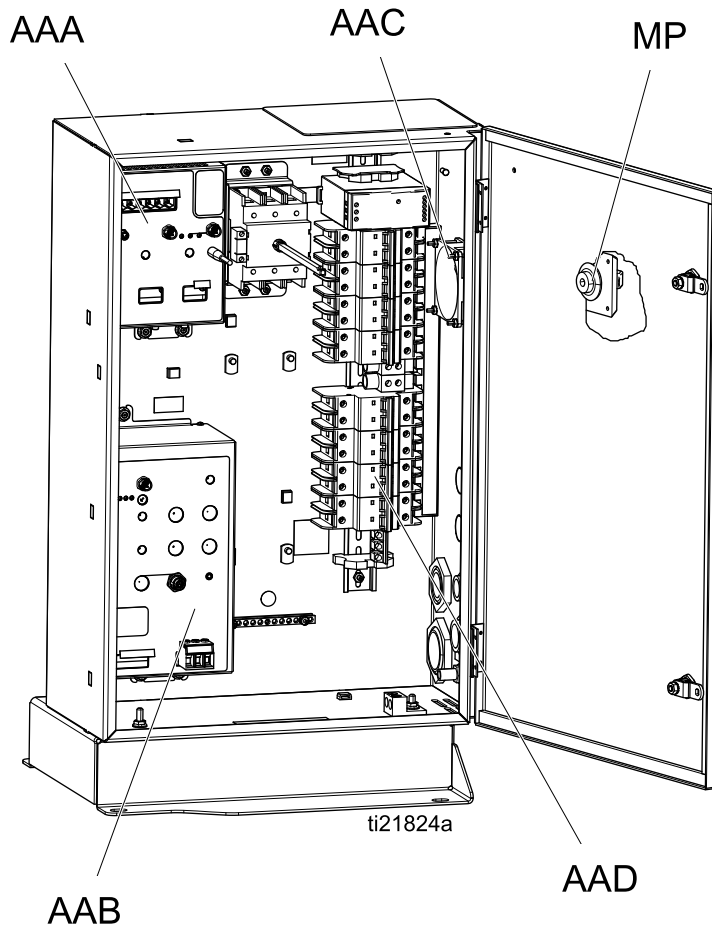

AAA Temperature Control Module (TCM)

AAB Motor Control Module (MCM)

AAC Enclosure Fan

AAD Circuit Breakers

MP Main Power Switch

Electrical Cabinet

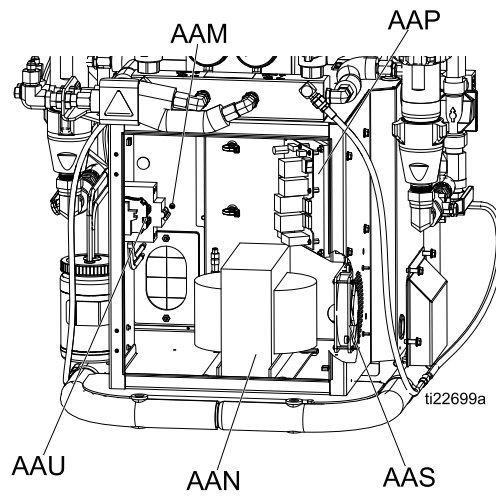

AAM Hose Breaker

AAN Transformer

AAP Load Center

AAS Fan

AAU Wiring Terminal Blocks

Motor Control Module (MCM)

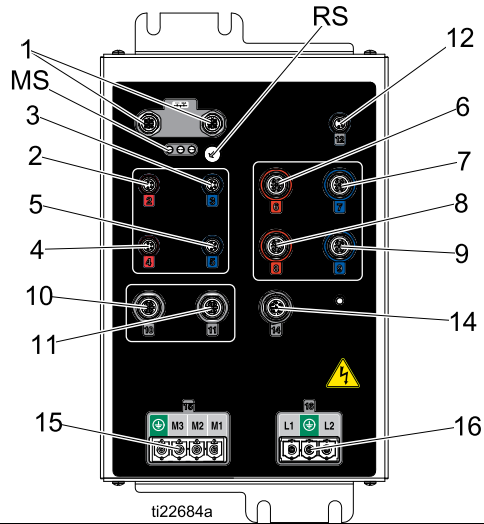
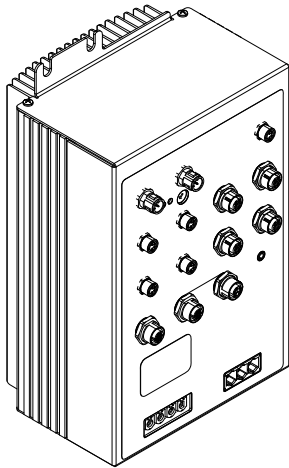

Figure 10

	Description
MB	Module Status LEDs see LED Status Table
1	CAN Communication Connections
2	Motor Temperature
3	Engine Coolant Temperature
4	Heat Exchanger A Temperature
5	Heat Exchanger B Temperature
6	A Pump Output Pressure
7	B Pump Output Pressure
8	A Fluid Inlet Sensor
9	B Fluid Inlet Sensor

10	Accessory Output
11	Load Center
12	Pump Cycle Counter
13	Not Used
14	Graco Insite™
15	Motor Power Output
16	Main Power Input

MCM Rotary Switch Positions

0=E-30i

1=E-XP2i

Table 3 MCM Module LED (MB) Status Descriptions

LED	Conditions	Description
MCM Status	Green Solid	Power applied to module
	Yellow Solid	Active Communication
	Red Steady Flashing	Software upload from token in progress
	Red Random Flashing or Solid	Module error exists

Engine Control Module

NOTICE

To prevent damage to the softkey buttons, do not press buttons with sharp objects such as pens, plastic cards, or fingernails.

For more information about the engine control module, see [Appendix A: Engine Control Module, page 81](#).

For system series "C" and following:

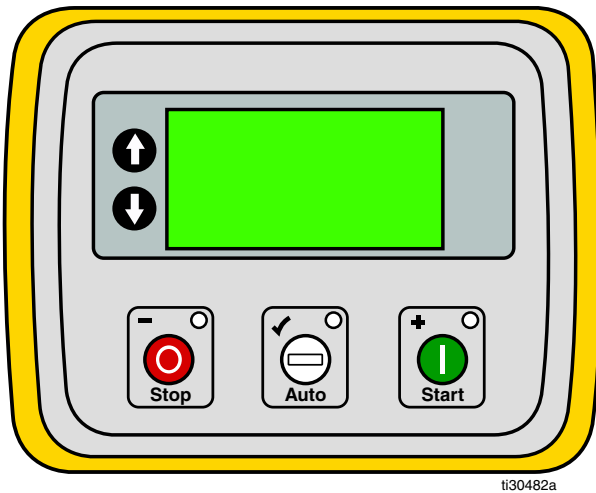

i130482a

Icon	Description	Function
	Start	Start Engine
	Auto	Auto mode (not used)
	Stop	Stop all system processes. Is not a safety or emergency stop.
	Scroll	Scroll through the instruments or recorded events on the currently displayed page
	Error Lamp (above and to the right of the Stop button)	Indicates error is present on generator

For system series "A" and "B" only:

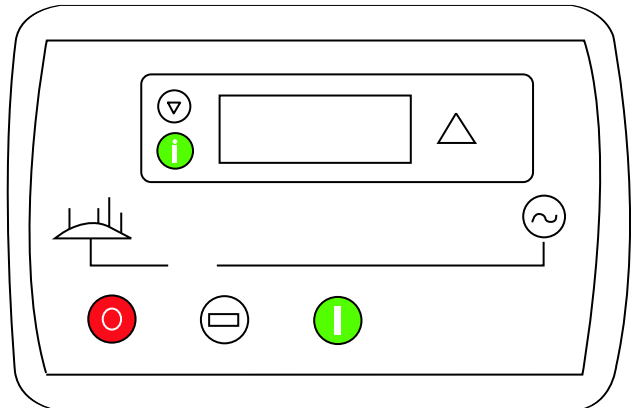
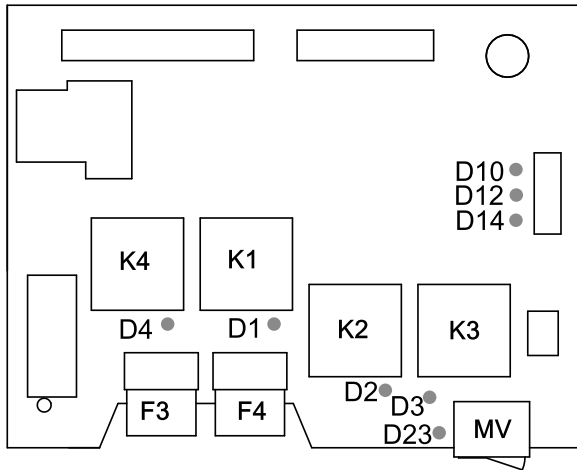

Figure 11

Icon	Description	Function
	On	Start Engine
	Auto	Auto mode (not used)
	Off	Stop all system processes. Is not a safety or emergency stop.
	Scroll	Scroll through the instruments or recorded events on the currently displayed page
	Page Select	Toggle between the information page and the error log page
	Error Lamp (above and to the right of the Stop button)	Indicates error is present on generator

Load Center



- F3 Radiator Fan Fuse
- F4 Load Center Power Fuse
- K1 Fuel Relay
- K2 Starter Relay
- K3 Glow Plug Relay
- K4 Radiator Fan Relay
- MV Manual Valve Switch

LED	Related Component	Color	ON-State Description
D1	Fuel Shutoff Solenoid (FS)	Green	Fuel shutoff solenoid on the engine is open.
D2	Starter (ST)	Red	Starter is cranking.
D3	Glow Plugs (GL)	Green	Glow plugs are heating.
D4	Radiator Fan (RF)	Green	Radiator fan is on.
D10	A Coolant Valve	Red	A-side (red) coolant valve is open.
D12	B Coolant Valve	Blue	B-side (blue) coolant valve is open.
D14	Bypass Coolant Valve	Green	Bypass coolant valve is open.
D23	Manual Valve Switch (MV)	Red	Manual valve switch is in the ON position.

Temperature Control Module (TCM) Cable Connections

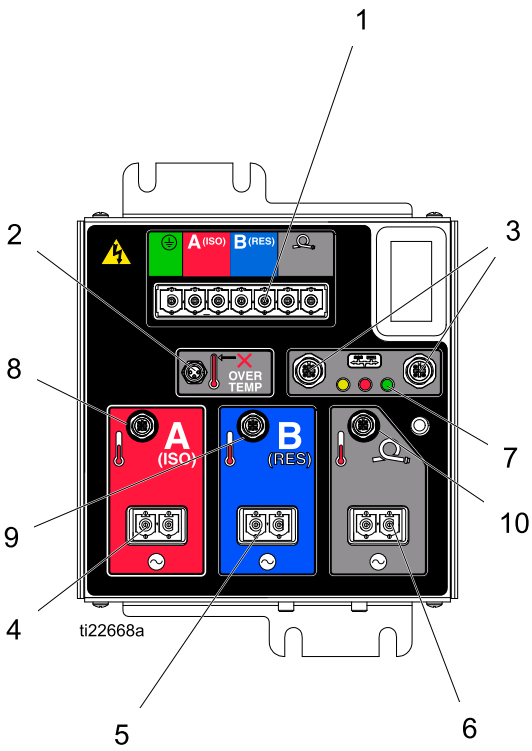

Figure 12

- 1 Power Input
- 2 Heater Overtemperature
- 3 CAN Communications Connections
- 4 Power Out (ISO)
- 5 Power Out (Res)
- 6 Power Out (Hose)
- 7 Module Status LEDs (see [Advanced Display Module \(ADM\), page 21](#), (CN) for conditions)
- 8 Boost Heater A Temperature (ISO)
- 9 Boost Heater B Temperature (RES)
- 10 Hose Temperature

Circuit Breakers

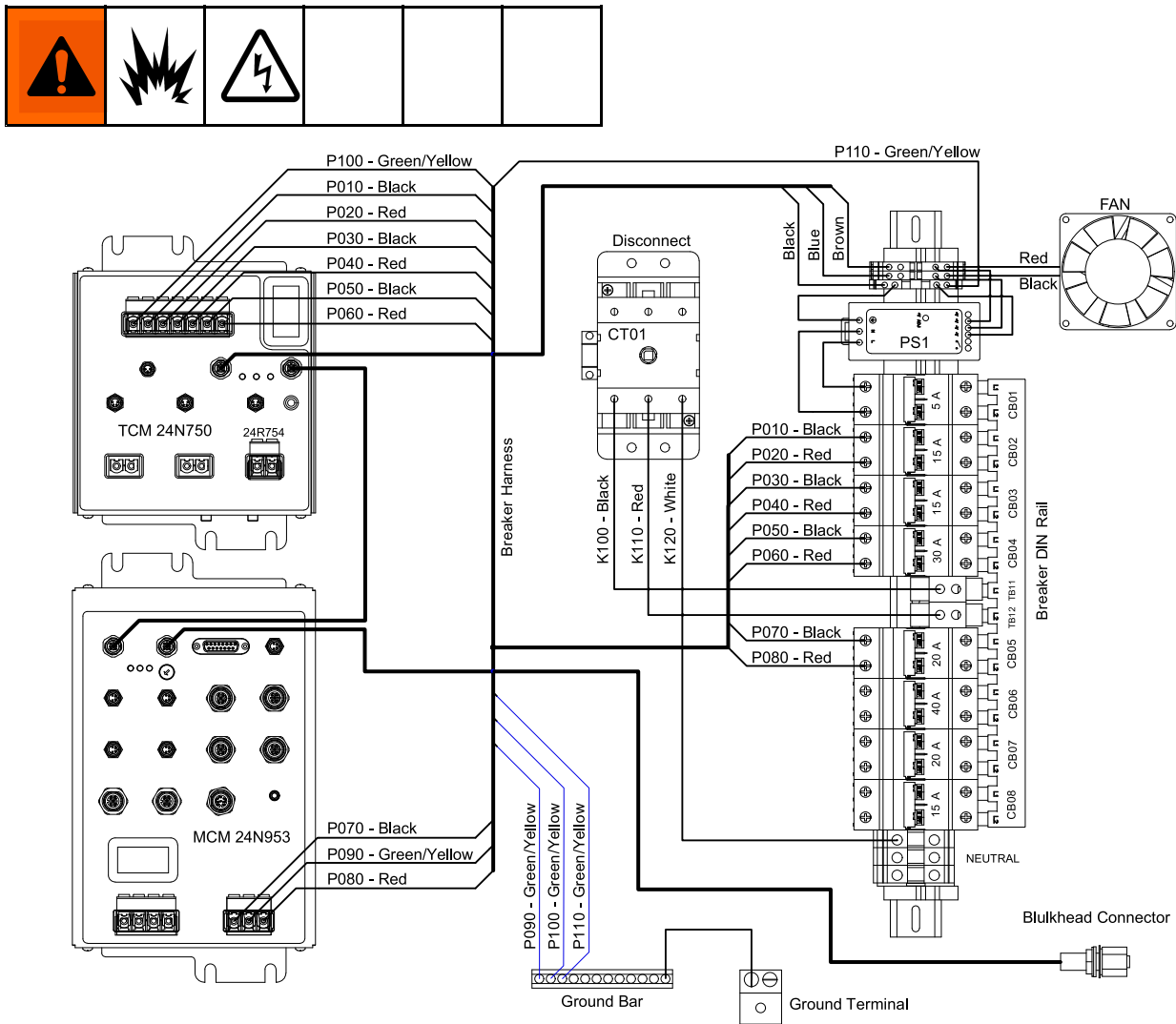

Figure 13 Circuit Breaker Connections Inside Electrical Enclosure (DB)

Note

Not all wires are shown.

Ref.	Size	Component
CB01	5 A	Power Supply, Fan, Coolant Pump
CB02	15 A	Boost Heat A
CB03	15 A	Boost Heat B
CB04	30 A	Hose Heat
CB05	20 A	Motor Control
CB06*	40 A	Air Compressor/Open
CB07*	20 A	Open
CB08*	15 A	Air Dryer/Open

* Contact Graco for circuit breaker options.

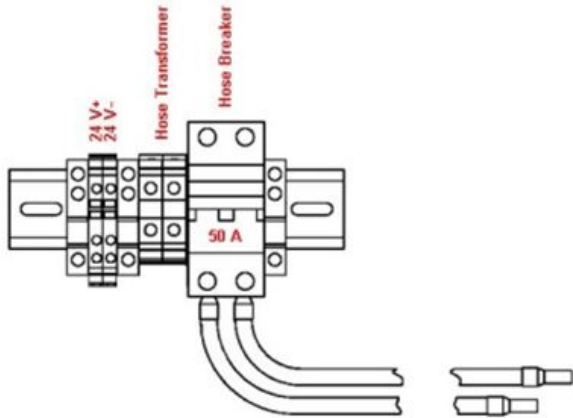

Figure 14 Circuit Breakers Inside Proportioner Cabinet

Ref.	Size	Component
CB20	50 A	Heated Hose

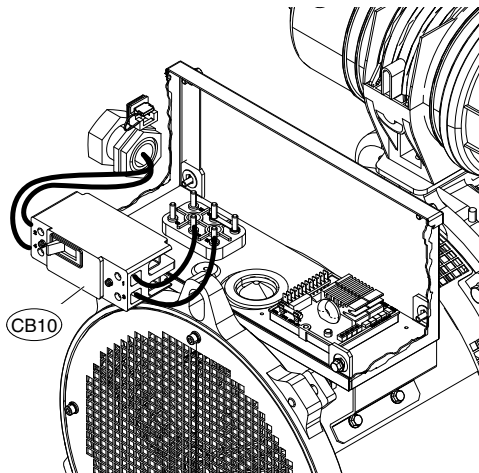

Figure 15 Circuit Breakers Inside Alternator Assembly

Ref.	Size	Component
CB10	90 A	120/240V Alternator

Circuit Breaker Configuration Options

<p>Improper configuration can result in electric shock. All electrical wiring must be done by a qualified electrician and comply with all local codes and regulations. See page 27 and 28 for correct circuit breaker configuration.</p>					

See [Circuit Breakers, page 32](#) for recommended circuit breaker configuration.

Sub-Panel Options

Some customer changes are acceptable to accommodate larger loads from auxiliary equipment or a sub-panel. It is suggested that circuit breakers CB07 be substituted to accommodate larger loads or a sub-panel. The total auxiliary equipment loads added to the configuration must be limited to the system's available auxiliary current. See [Models, page 10](#), for available auxiliary current at 240V, 60Hz.

See the Reactor repair manual for optional circuit breakers and their current ratings. Circuit breakers used must meet UL489 specifications.

Auxiliary Wiring Diagram Options.

The generator supplies power in a 3-wire, single-phase, mid-point neutral wiring configuration. For 240 VAC loads, wire the load across the output terminals of the circuit breaker. For 120 VAC loads, wire the load between the neutral terminal blocks below the circuit breaker to one pole of the circuit breaker. See electrical diagrams in Reactor repair manual.

Disable Booster Heat

Disable booster heat to allow use of power for additional auxiliary power.

To replace or repair a circuit breaker, see the Reactor 2 Integrated Repair manual.

Overview

The system uses two coolant loops to use heat released from the engine to heat the A and B component material to the target temperatures defined on the ADM (PD).

The engine coolant loop (gray) circulates heated coolant from the engine (EE), through the heat exchanger (HE), radiator (ER), and back to the engine. Coolant in the proportioner coolant loop (black) captures heat from the engine coolant loop inside the heat exchanger (HE) near the radiator.

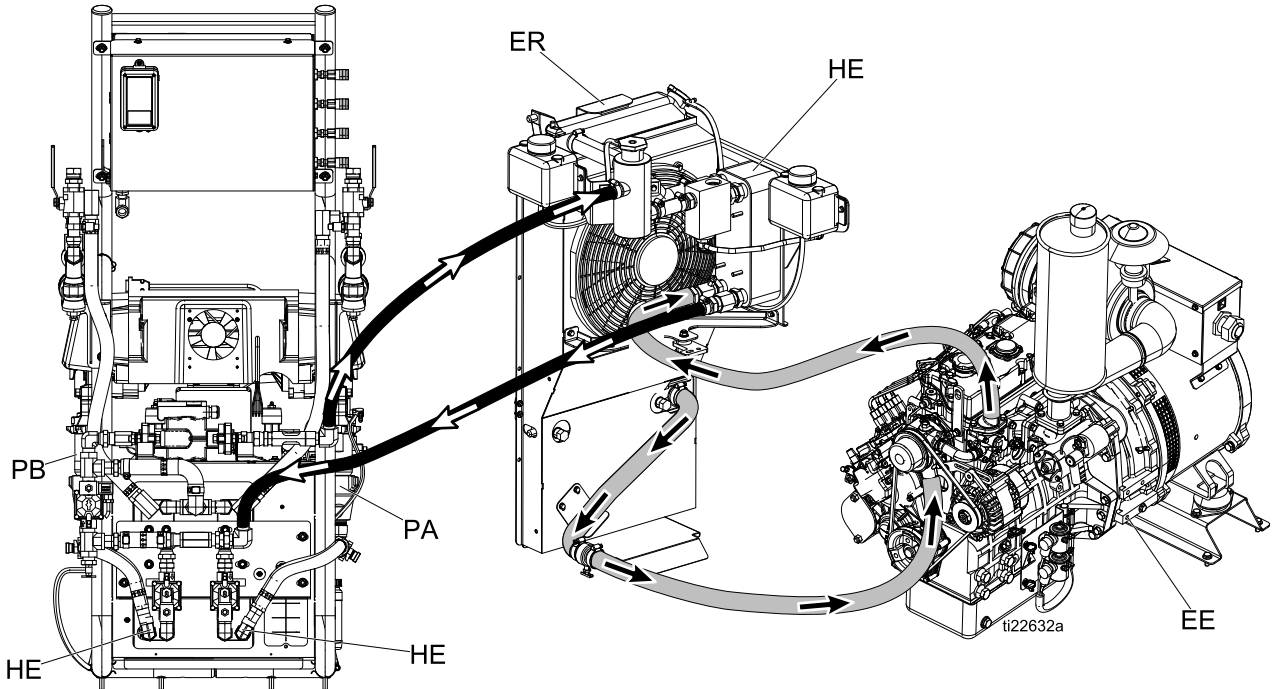

Figure 16 Engine Coolant Loop and Proportioner Coolant Loop

The proportioner coolant loop circulates coolant through secondary heat exchangers (HE) located on the back of the proportioner to heat the A and B component material before the material is pressurized in the proportioner pumps (PA, PB). After the A and B material has been heated in the heat exchangers, the material enters the fluid manifold (FM) and heated hose.

For models with a booster heater, the A and B material enters the booster heater after the material is pressurized in the proportioning pumps to heat the material higher than 140°F (60°C).

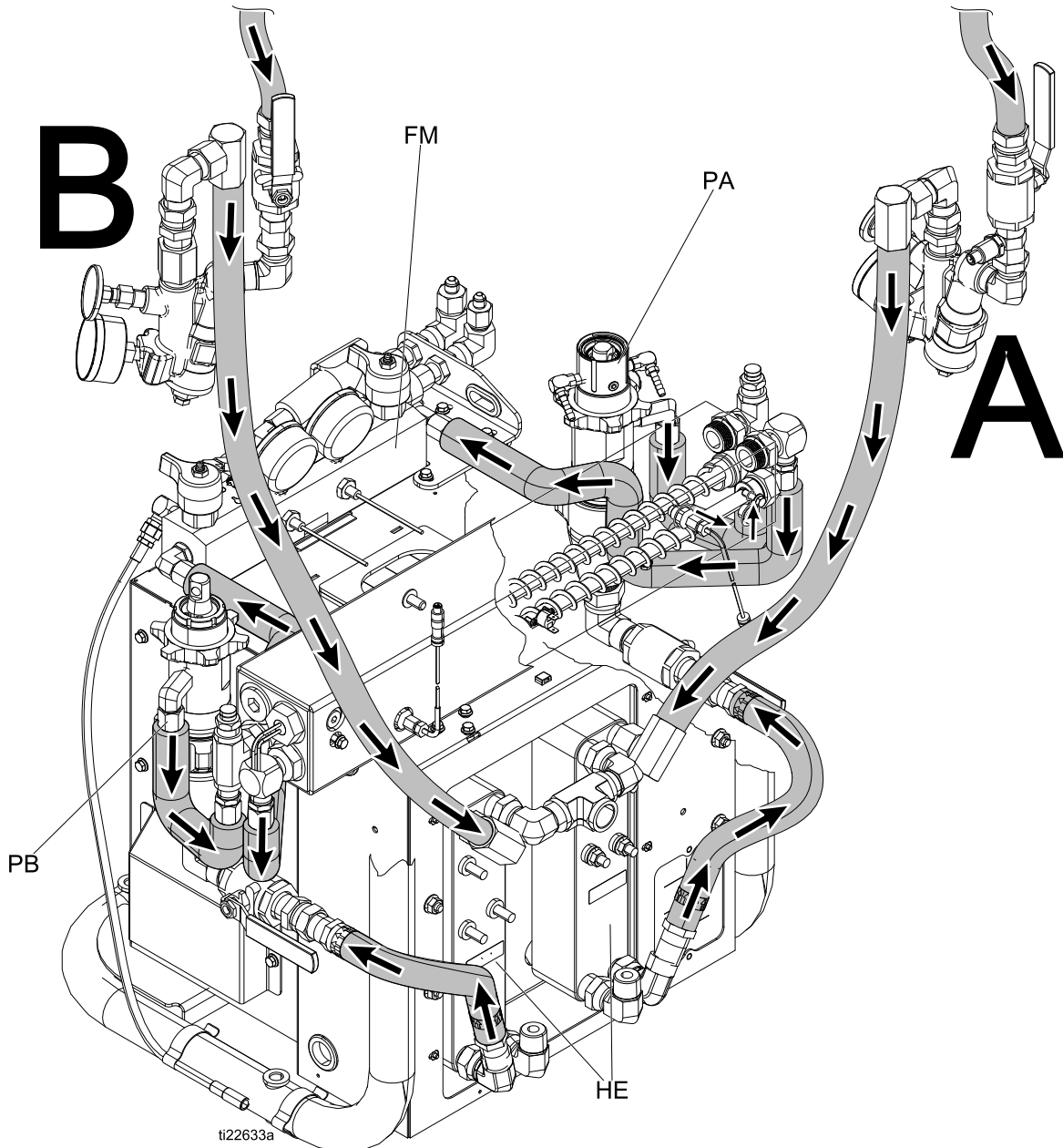

Figure 17 A and B Component Material Flow

Overview

Coolant only flows through the secondary heat exchangers when the heat exchanger control valves (VA, VB) are open and the A and B component temperatures are below the target temperatures set on the ADM. See Fig 18.

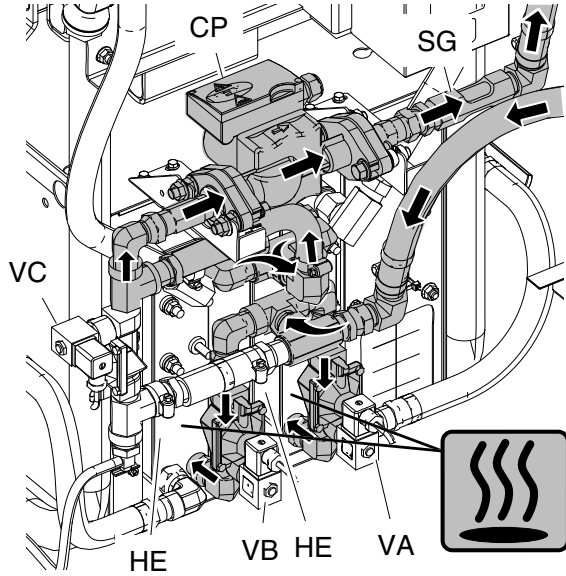

Figure 18 Proportioner Coolant Loop — A and B Valves Open (heating material)

When the control valves (VA, VB) close, the A and B material has reached target temperature. Coolant flows through the bypass control valve (VC), circulation pump (CP), sight glass (SG), proportioner coolant fill bottle (HF), and back to the heat exchanger in the engine coolant loop. See Fig. 19.

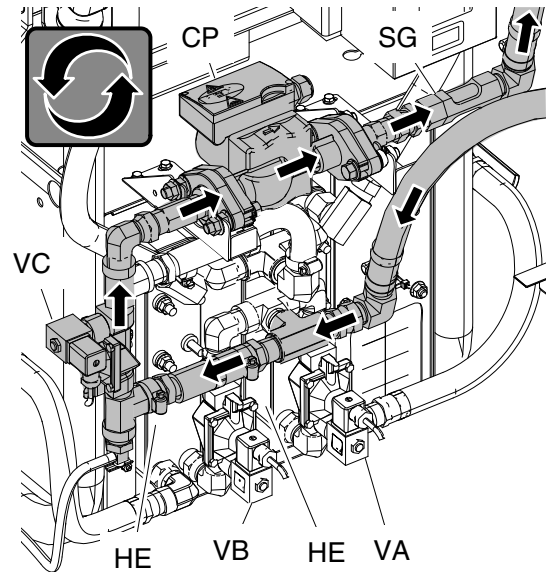

Figure 19 Proportioner Coolant Loop — A and B Valves Closed (not heating material)

Setup

NOTICE

Proper system setup, startup, and shutdown procedures are critical to electrical equipment reliability. The following procedures ensure steady voltage. Failure to follow these procedures will cause voltage fluctuations that can damage electrical equipment and void the warranty.



Do not remove or separate the proportioner, engine assembly, or power distribution box from the pallet. Failure to leave the component mounting intact will cause heating efficiency degradation, and potential unsafe wiring and grounding.

Locate Reactor

1. Install hose rack, if ordered. See manual 3A1903 for detailed instructions.
2. Locate Reactor on a level surface that is nonporous and diesel resistant, such as diamond plate.

Note

Leave at least 1 ft. (0.3m) distance from the engine side of the pallet to any wall for engine maintenance access.

3. Do not expose Reactor to rain or below 20°F (-7°C).

NOTICE

To ensure the heat exchanger control valves open and close properly, do not store Reactor below 20°F (-7°C).

4. If a wall will be installed between the proportioner and generator, remove the fuel tank and battery bracket. See [Trailer Setup Guidelines, page 38](#).
5. To mount in a trailer, use forklift to move Reactor by inserting the forks through the Reactor pallet frame. It is recommended to lift from the engine side. Bolt pallet directly to trailer frame.

Note

Use Pallet Support Kit 24L911 (rollers not included) to relocate pallet to mounting location when forks are unavailable. See kit manual for instructions.

NOTICE

Keep the vent holes in the bottom of the proportioner cabinet open. Make sure there is unobstructed incoming air for the cooling fan at the top of the proportioner cabinet that blows air up into the electric motor. Failure to provide unobstructed incoming air can cause the motor to overheat.

Trailer Setup Guidelines

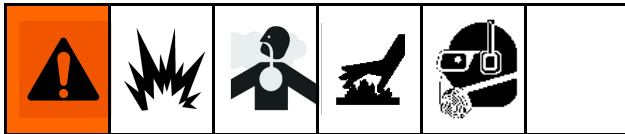

Route exhaust system away from combustible materials to prevent materials from igniting or gas recirculation into a wall, ceiling, or a concealed space. Provide exhaust system guards to prevent burns.

NOTICE

Provide recommended size louvers. Failure to do so can damage the engine and void the engine warranty.

Exhaust pipes that pass through flammable ceilings must be guarded by vented metal thimbles that extend at least 9 in. (228.6 mm) below and above the roof and are at least 6 in. (152.4 mm) in diameter larger than the exhaust pipe.

Exhaust pipes that pass through flammable walls must be guarded by either:

- Metal ventilated thimble at least 12 in. (305 mm) larger than the diameter of the exhaust pipe.
- Metal or other approved fireproofing materials that provides at least 8 in. (203 mm) of insulation between the exhaust pipe and flammable material.

Exhaust pipes not covered above must have at least 9 in. (228.6 mm) of clearance from the outside of the exhaust pipe to adjacent flammable materials.

1. Provide sufficient lighting to safely operate and maintain system equipment.

2. Provide radiator exhaust for Reactor. Use a 400 in.² (258,064 mm²) minimum louver.
3. Provide air duct to connect radiator exhaust to louver.
4. Provide a 400 in.² (258,064 mm²) minimum fresh air intake louver near the generator.
5. Remove red exhaust cap.
6. Provide a minimum 2 in. (50.8 mm) diameter engine exhaust outlet with flexible pipe element. Provide rain cap, or equivalent routing, to prevent moisture from entering the metal exhaust pipe.

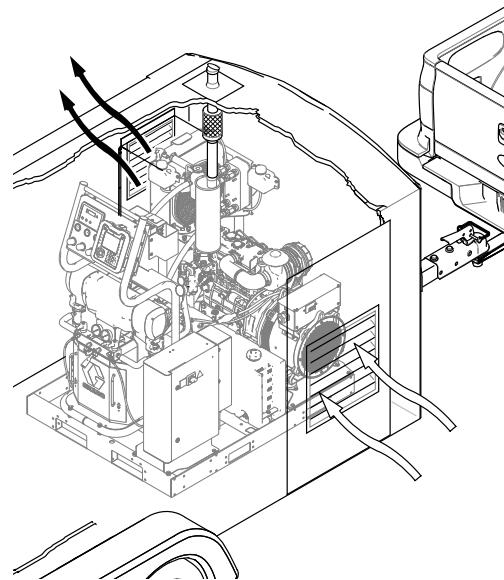

Radiator Exhaust and Air Intake Louvers
Figure 20

Install Wall (optional)

It is only possible to install a wall between the proportioner and generator for systems without an air compressor.

Benefits:

- Temperature condition the trailer space where chemical is stored. Check with chemical manufacturer for chemical storage temperatures.
- Reduce noise for the operator while the Reactor is running.

The supplied fuel lines and battery cable may need to be replaced if a wall is installed between the proportioner and generator. Purchase the Fuel Line and Battery Cable Extension Kit 24K333.

1. If necessary drain coolant from system. See Reactor repair manual for complete instructions. Coolant lines do not need to be disconnected to install a wall.

Note

Battery must be connected to starter to drain coolant from system.

2. Remove screws and battery bracket from the pallet.

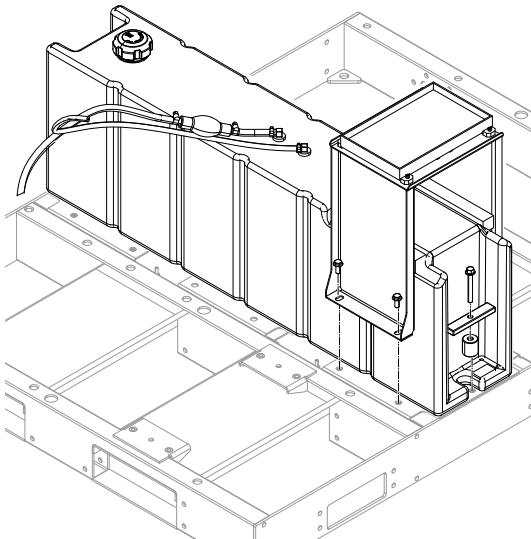

Remove Battery Bracket and Fuel Tank
Figure 21

3. Remove fuel tank from the pallet.
 - a. Remove the mounting screws, supports, and spacers.
 - b. Disconnect inlet and outlet fuel lines from the fuel tank.
 - c. Use two people to lift fuel tank off of the pallet and place where the fuel fill spout is easily accessible.

Note

Do not mount fuel tank in front of the generator air intake or where it will limit opening and access to the electrical enclosure (DB).

4. Install wall (IW) where the fuel tank was located. Ensure there is at least 1.25 in. (31.75 mm) between the wall and exhaust muffler. See [Fig. 22](#).

Note

To prevent an air pocket from forming inside the coolant lines between the proportioner and generator, ensure there is a constant rise in elevation if the coolant lines are adjusted. Failure to have a constant rise in elevation will reduce heating efficiency. See [Fig. 23](#).

5. Reconnect inlet and outlet fuel lines.
6. Install spacers, supports, and screws through the fuel tank and tighten to the floor. Torque to 40 ft-lbs (54 N•m).
7. Place battery bracket over fuel tank or near the Reactor. Remove existing battery cables from engine and replace with the cables provided from the fuel line and battery cable extension kit.
8. Install mounting bolts through battery bracket and tighten to the floor. Torque to 40 ft-lbs (54 N•m).

Note

Pads under the battery bracket help stabilize the fuel tank during operation.

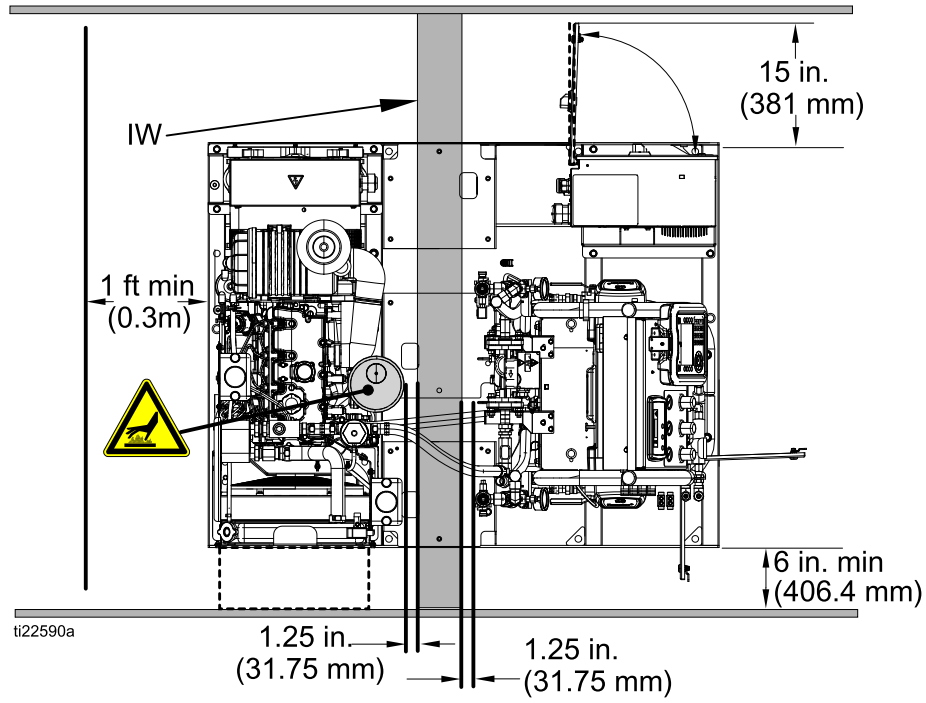

Figure 22 Top View With Wall

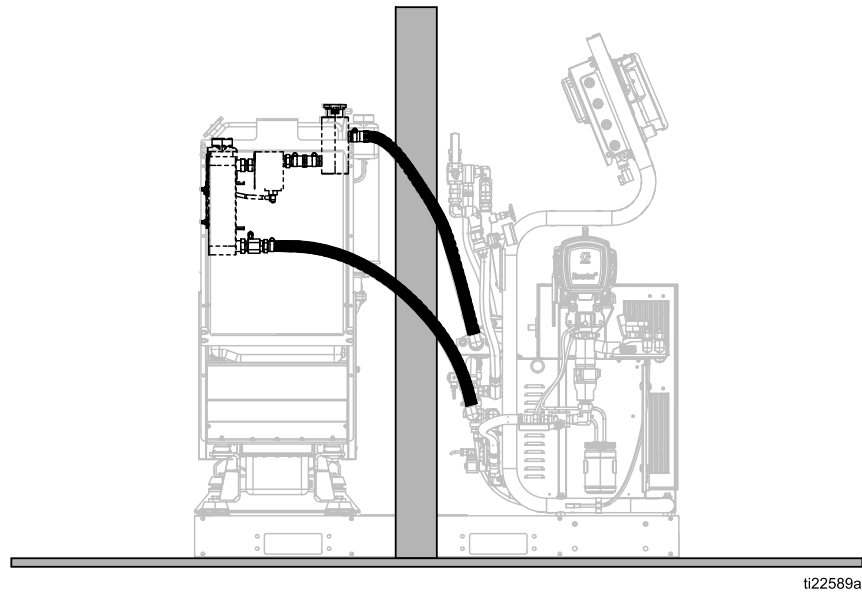





Figure 23 Side View With Wall

Connect Battery

					
<p>Improper battery installation or maintenance may result in electric shock, chemical burns, or explosion. Battery maintenance must only be performed or supervised by personnel knowledgeable of batteries and the required precautions. Keep unauthorized personnel away from batteries.</p>					

See [Technical Specifications, page 92](#) for battery requirements and recommended battery size.

1. Secure battery (not supplied) to bracket with strap.

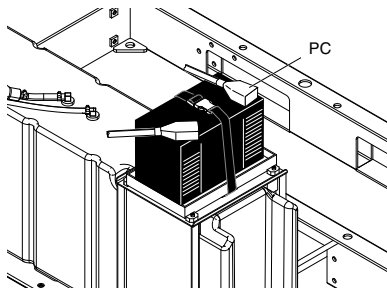

Battery Connections
Figure 24

2. Connect battery cable from the engine starter (ST) and chassis to the battery. Connect the black cable to battery negative (-) and the red cable to battery positive (+).

NOTICE

Always connect the red battery cable to battery positive (+) and the black battery cable to the battery negative (-). Failure to properly connect the battery cable to the battery will damage the fusible link when the engine control module is turned ON. Do not bypass the fusible link when damaged. The fusible link prevents damage to other system components. See the system repair manual for repair instructions.

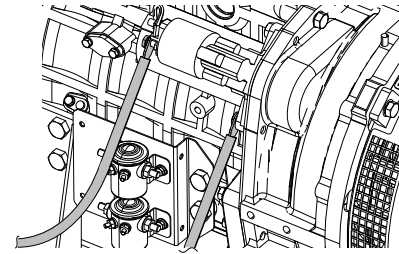

Engine Starter Connections
Figure 25

3. Cover battery terminals with plastic caps (PC) attached to supplied battery cables.
4. Verify battery was connected properly by pressing OFF  on the engine control module (PE) to “wake up” the controller screen. Do not attempt to start the engine until all Setup steps are complete. See Repair manual if engine control module does not light up.

Add Fuel

1. Remove fuel cap (FS) and fill fuel tank with no more than 20 gallons (75 liters) of diesel fuel. Replace cap. See Perkins engine manual for approved diesel fuels.
2. Squeeze prime bulb (P) to prime engine. Press the prime bulb repeatedly until fuel begins to return to the fuel tank.

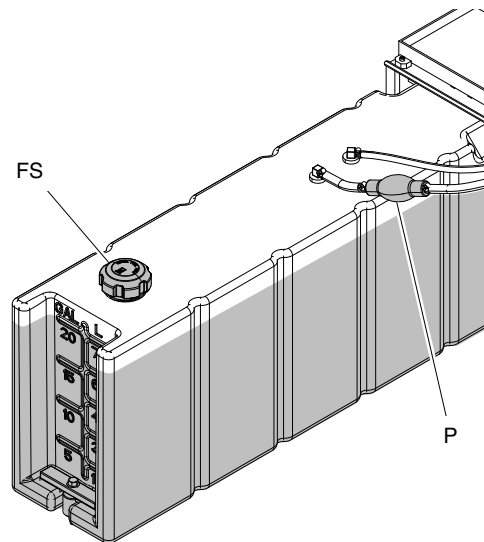

Figure 26

General Equipment Guidelines

Maintain and inspect the generator, air compressor, and other equipment per the manufacturer recommendations to avoid an unexpected shutdown. Unexpected equipment shutdown will cause voltage fluctuations that can damage electrical equipment.

Electrical Connections

Connect air compressor, breathing air, and auxiliary power electrical connections to the specified circuit breakers. See [Circuit Breakers, page 32](#).

1. Remove one or more knock-outs on side of electrical enclosure, as required, and route wires through for air compressor, breathing air, and auxiliary equipment. See [Circuit Breaker Configuration Options, page 33](#), for more information.

Connect Feed Pumps

For illustrations of a system with feed pumps, see [Typical Installation, with circulation, page 15](#) and [Typical Installation, without circulation, page 14](#).

1. Install feed pumps (K) in component A and B supply drums.
2. Seal component A drum and use desiccant dryer (M) in vent.
3. Install agitator (L) in component B drum, if necessary.
4. Connect supply hoses from feed pumps to the component A and component B material inlets on the system. Ensure A and B inlet valves are closed.

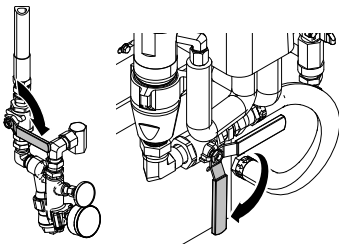

Note

Supply hoses from feed pumps should be 3/4 in. (199 mm) ID.

5. Connect air lines to proportioner. Ensure components are properly connected to correct location.

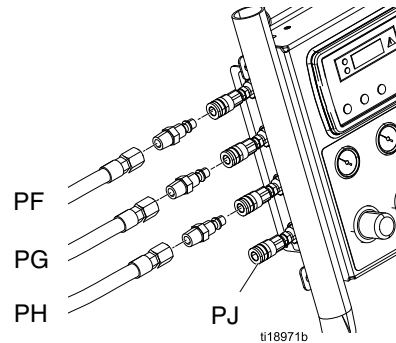

Ref	Air Outlet
PF	A Pump
PG	B Pump
PH	Agitator
PJ	Gun



Note

Agitator air supply (PH) includes a small internal restriction orifice to limit the air flow to minimize air compressor load. Maximum supplied air flow is 2.0 scfm (0.1 m³/min) at 100 psi (0.7 MPa, 7 bar). Designed for use with Twistork agitator 224854. Do not use the agitator air outlet (PH) for any other component.

Breathing Air

Breathing the air from the compressed air supply can cause serious injury if inhaled.					
<ul style="list-style-type: none"> • Only use an independent and approved breathing air system with adequate air flow to provide clean breathable air. 					

Connect Pressure Relief Lines

					
Do not operate Reactor without all covers and shrouds in place.					

1. **Recommended:** Connect high pressure hose (R) to relief fittings (BA, BB) of both PRESSURE RELIEF/SPRAY valves. Route hose back to component A and B drums. See [Typical Installation, with circulation, page 15](#).
2. **Alternately:** Secure supplied bleed tubes (N) in grounded, sealed waste containers (H). See [Typical Installation, without circulation, page 14](#).

Install Fluid Temperature Sensor

The Fluid Temperature Sensor (FTS) is supplied. Install FTS between main hose and whip hose. See Heated Hose manual for instructions.

Connect Heated Hose to Proportioner

See Heated Hose manual for detailed instructions on connecting heated hoses.

Note

The FTS (C) and whip hose (D) must be used with heated hose. Hose length, including whip hose, must be 60 ft (18.3 m) minimum.

NOTICE

Apply grease on all system and hose fluid fittings. This lubricates the threads and prevents material from hardening on the threads.



1. Turn main power switch OFF
2. Assemble heated hose sections, FTS, and whip hose.
3. Connect A and B hoses to A and B outlets on Reactor fluid manifold (FM). Hoses are color coded: red for component A (ISO), blue for component B (RES). Fittings are sized to prevent connection errors.

Note

Manifold hose adapters (HA, HB) allow use of 1/4 in. and 3/8 in. ID fluid hoses. To use 1/2 in. (13 mm) ID fluid hoses, remove adapters from fluid manifold and install as needed to connect whip hose.

Setup

4. For proportioners with electrical splice connectors: Connect cables (C). Connect electrical connectors (V). Follow procedures in heated hose manual. Be sure cables have slack when hose bends. Wrap cable and electrical connections with electrical tape.

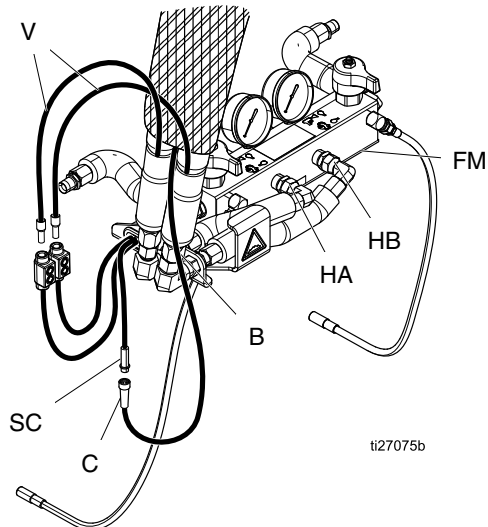

Figure 27 Electrical Splice Connectors

5. For proportioners with termination box (TB):
 - a. Connect hose power wires to terminal block (T) on termination box (TB). Remove box cover and loosen lower strain relief (E). Route hose wires (V) through the box strain relief and fully insert into terminal block (T). A and B hose wire positions are not important. Torque to 26–30 in-lbs (2.9–3.3 N·m).
 - b. Fully tighten strain relief screws and replace cover.

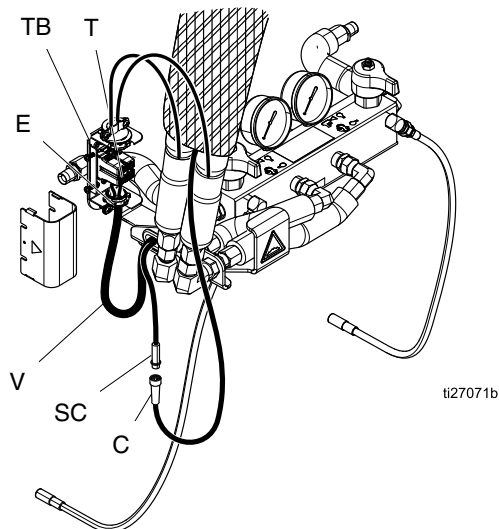

Figure 28 Termination Box

6. Connect quick-disconnect pin fitting to 4 ft air hose, shipped loose. Connect other hose end to the gun air hose in the heated hose bundle. Push pin fitting into the lowest air panel outlet (PJ).

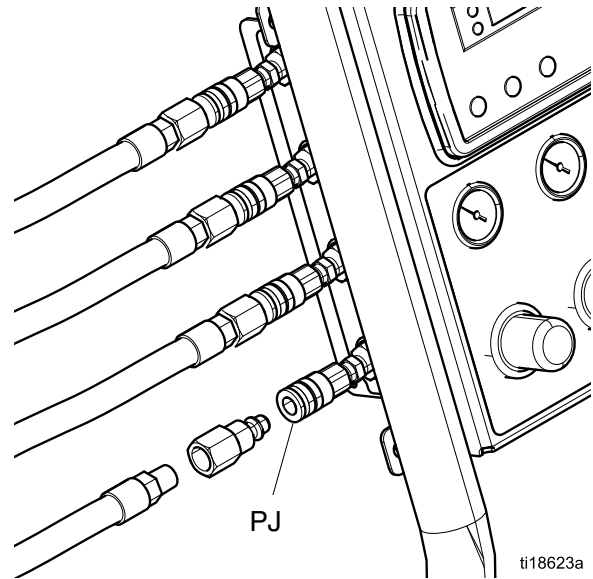
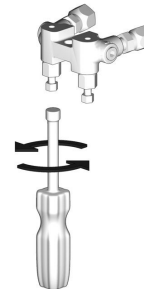

Figure 29

Close gun fluid manifold valves A and B



Connect Whip Hose to Gun Or Gun Fluid Manifold

See hose manual for proper connections.





Pressure Check Hose

See hose manual. Pressure check for leaks. If no leaks, wrap hose and electrical connections to protect from damage.

Connect Remote Display Module

See Remote Display Module kit manual for installation instructions.

Grounding

					
<p>The equipment must be grounded to reduce the risk of static sparking and electric shock. Electric or static sparking can cause fumes to ignite or explode. Improper grounding can cause electric shock. Grounding provides an escape wire for the electric current.</p>					

- *Reactor System:* System must be grounded with an appropriately sized conductor to the trailer or vehicle chassis or, if stationary, to true earth ground. Remove bolt and braided cable from pallet. Install grounding cable terminated with a ring terminal (cable and terminal not supplied) under braided cable. Reinstall bolt and torque to minimum 25 ft-lbs (34 N•m). An alternate grounding location is to the ground bar in the electrical enclosure. Follow all National, State, and Local safety and fire codes.

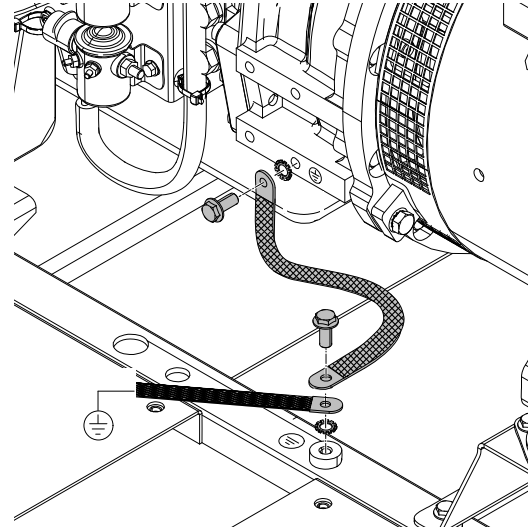

- *Spray gun:* connect whip hose ground wire to FTS. See [Install Fluid Temperature Sensor, page 43](#). Do not disconnect ground wire or spray without whip hose.
- *Fluid supply containers:* follow your local code.
- *Object being sprayed:* follow your local code.
- *Solvent pails used when flushing:* follow your local code. Use only metal pails, which are conductive, placed on a grounded surface. Do not place pail on a nonconductive surface, such as paper or cardboard, which interrupts grounding continuity.
- *To maintain grounding continuity when flushing or relieving pressure,* hold a metal part of spray gun firmly to the side of a grounded *metal* pail, then trigger gun.

Supply Wet Cups With Throat Seal Liquid (TSL)

<p>Pump rod and connecting rod move during operation. Moving parts can cause serious injury such as pinching or amputation. Keep hands and fingers away from wet-cup during operation.</p>					

To prevent the pump from moving, turn the main power switch OFF.



- **Component A (ISO) Pump:** Keep reservoir (R) filled with clean Graco Throat Seal Liquid (TSL), Part 206995. Wet-cup piston circulates TSL through wet-cup, to carry away isocyanate film on displacement rod.

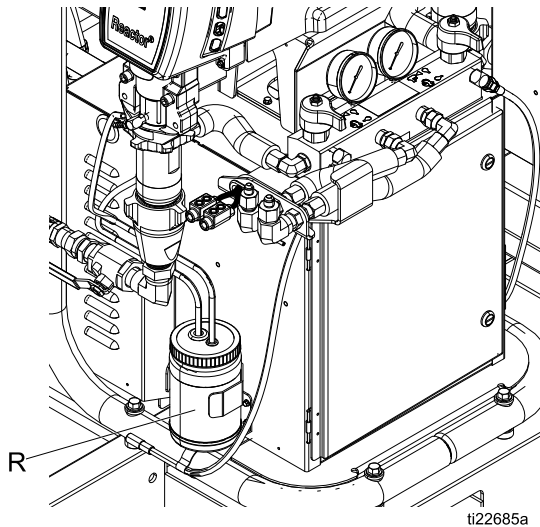
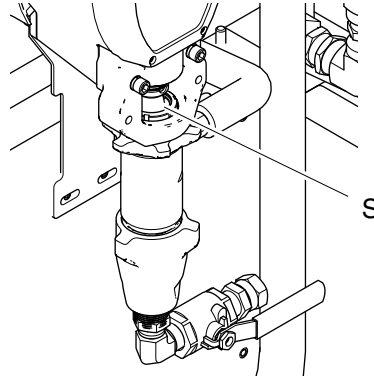

Figure 30 Component A Pump

- **Component B (Resin) Pump:** Check felt washers in packing nut/wet-cup (S) daily. Keep saturated with Graco Throat Seal Liquid (TSL), Part No. 206995, to prevent material from hardening on displacement rod. Replace felt washers when worn or contaminated with hardened material.



Component B Pump

Figure 31

Operation

1. Turn the main power switch ON. The Graco logo will display until communication and initialization is complete.



2. Press the on/off button .

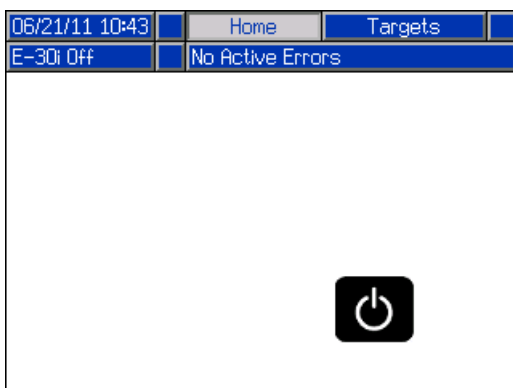

3. Verify the machine is active and the System Status LED is illuminated green, see [Advanced Display Module \(ADM\), page 21](#). If the System Status LED is not green, press the ADM Power On/Off (A) button . The System Status LED will illuminate yellow if the machine is disabled.

Initial System Setup

Perform the following tasks to fully setup your system.

1. Select pressure for the Pressure Imbalance Alarm to activate. See [System Screen , page 51](#).
2. Enter, enable, or disable recipes. See [Recipes Screen, page 56](#).
3. Set general system settings. See [Advanced Screen 1 — General, page 50](#).
4. Set units of measure. See [Advanced Screen 2 — Units, page 50](#).
5. Set USB settings. See [Advanced Screen 3— USB, page 50](#).
6. Set target temperatures and pressure. See [Targets, page 53](#).
7. Set component A and component B supply levels. See [Maintenance, page 54](#).
8. Ensure engine is at operating temperature on the home screen.

Register and Activate the Graco Insite

1. Go to www.GracoInSite.com, click on "InSite Login", then follow the instructions on the screen.
2. Find and record the 15 digit serial number from the cellular box below.

Serial No.



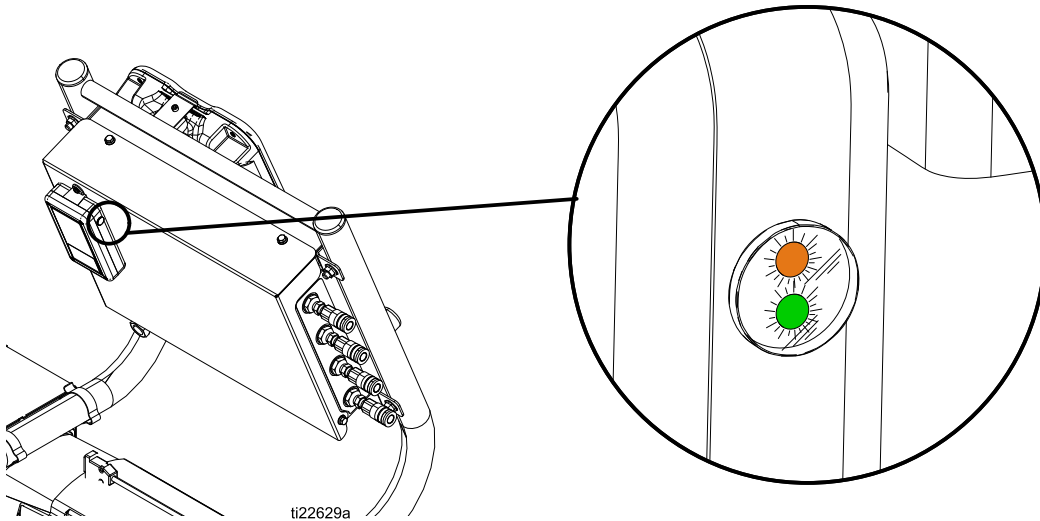

Verify Module Status

To check the status of the cellular module, locate the status LEDs on the module then refer to the following chart.

LED Status	Description
Green flashing	Finding GPS location
Green solid	GPS location identified
Orange flashing	Cellular connection in process
Orange solid	Cellular connection established
Green and orange off	Reactor power is OFF



Setup Mode

The ADM will start in the Run screens at the Home screen. From the Run screens, press  to access the Setup screens. The system defaults with no password, entered as 0000. Enter the current password then press . Press   to navigate through the Setup Mode screens.



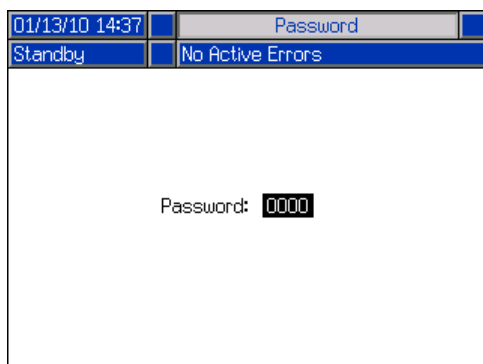

Set Password

Set a password to allow Setup screen access, see [Advanced Screen 1 — General, page 50](#). Enter any number from 0001 to 9999. To remove the password, enter the current password in the Advanced Screen – General screen and change the password to 0000.



From the Setup screens, press  to return to the Run screens.

Advanced Setup Screens

Advanced setup screens enable users to set units, adjust values, set formats, and view software information for each component. Press   to scroll through the Advanced setup screens, Once in the desired Advanced setup screen, press  to access the fields and make changes. When changes are complete press  to exit edit mode.

Note

Users must be out of edit mode to scroll through the Advanced setup screens.

Advanced Screen 1 — General

Use this screen to set the language, date format, current date, time, setup screens password (0000 – for none) or (0001 to 9999), and screen saver delay.

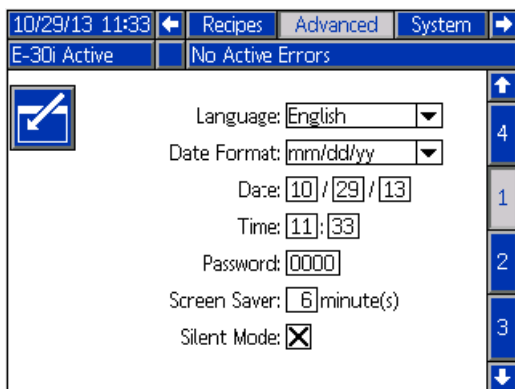

10/29/13 11:33 ← Recipes Advanced System →

E-30i Active | No Active Errors



Language: English

Date Format: mm/dd/yy

Date: 10 / 29 / 13

Time: 11 : 33

Password: 0000

Screen Saver: 6 minute(s)

Silent Mode:

Advanced Screen 2 — Units

Use this screen to set the temperature units, pressure units, volume units, and cycle units (pump cycles or volume).

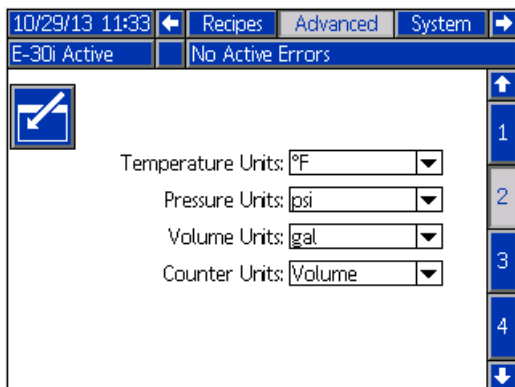

10/29/13 11:33 ← Recipes Advanced System →

E-30i Active | No Active Errors



Temperature Units: °F

Pressure Units: psi

Volume Units: gal

Counter Units: Volume

Advanced Screen 3 — USB

Use this screen to disable USB downloads/uploads, disable USB log errors, enter the maximum number of days to download data, and how frequently USB logs are recorded. See [USB Data, page 77](#).

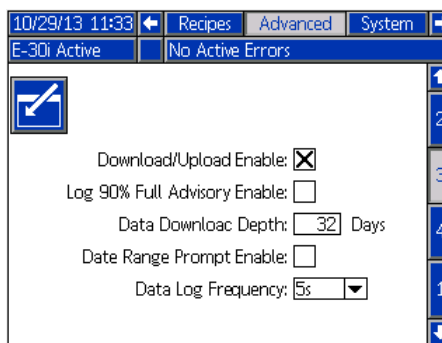

10/29/13 11:33 ← Recipes Advanced System →

E-30i Active | No Active Errors



Download/Upload Enable:

Log 90% Full Advisory Enable:

Data Download Depth: 32 Days

Date Range Prompt Enable:

Data Log Frequency: 5s

Advanced Screen 4— Software

This screen displays the software part number and software version for the Advanced Display Module, USB Configuration, Motor Control Module, and Temperature Control Modules.

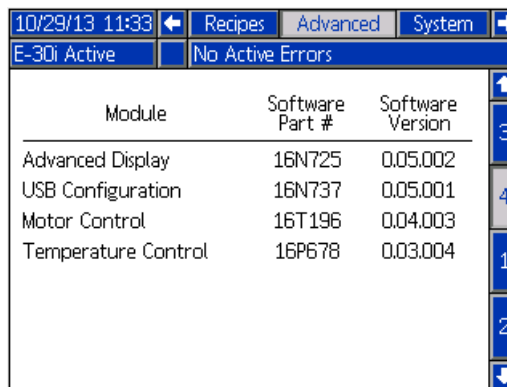

Module	Software Part #	Software Version
Advanced Display	16N725	0.05.002
USB Configuration	16N737	0.05.001
Motor Control	16T196	0.04.003
Temperature Control	16P678	0.03.004

System 1

Use this screen to set the activation pressure for the Pressure Imbalance Alarm and Deviation, enable or disable diagnostic screens, set the maximum and minimum drum volume, and enable drum alarms.

Recipes

Use this screen to add recipes, view saved recipes, and enable or disable saved recipes. Enabled recipes can be selected at the Home Run Screen. 24 recipes can be displayed on the three recipe screens.





	A	B	Q		
	°F	°F	°F	psi	Enabled
RECIPE A	32	32	32	0	<input type="checkbox"/>
RECIPE B	32	32	32	0	<input type="checkbox"/>
RECIPE C	32	32	32	0	<input type="checkbox"/>
RECIPE D	32	32	32	0	<input type="checkbox"/>
RECIPE E	32	32	32	0	<input type="checkbox"/>
RECIPE F	32	32	32	0	<input type="checkbox"/>
RECIPE G	32	32	32	0	<input type="checkbox"/>
RECIPE H	32	32	32	0	<input type="checkbox"/>

System 2



Use this screen to enable Manual Hose Mode, Boost Heat, and inlet sensors, as well as setting the inlet sensor low pressure alarm and low temperature deviation. Manual Hose Mode disables the hose temperature RTD sensor so the system can operate if the sensors were to malfunction.

Boost heaters can be disabled if not needed. If they stay disabled the extra power can be used for auxiliary equipment. Inlet sensor default settings are 10 psi (0.07 MPa, 0.7 bar) for low inlet pressure alarm and 50°F (10°C) for low inlet temperature deviation.



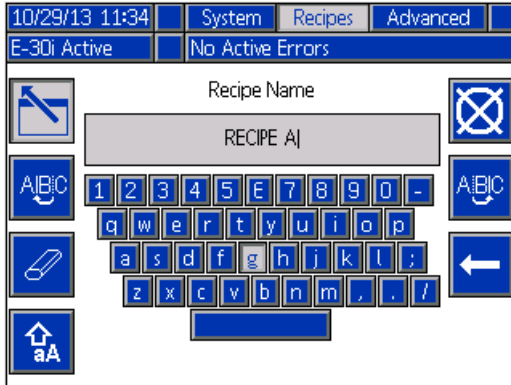



Add Recipe

1. Press  and then use   to select a recipe field. Press  to enter a recipe name (maximum 16 characters). Press  to clear the old recipe name.





2. Use   to highlight the next field and use the number pad to enter a value. Press  to save.

Enable or Disable Recipes

1. Press  and then use   to select the recipe that needs to be enabled or disabled.
2. Use   to highlight the enabled check box. Press  to enable or disable the recipe.

Run Mode

The ADM will start in the Run screens at the “Home” screen. Press   to navigate through the Run Mode screens.

Or press  to access the Setup screens.

Home — System Off

This is the home screen when the system is off. This screen displays actual temperatures, actual pressures at the fluid manifold, jog speed, coolant temperature, and number of cycles.

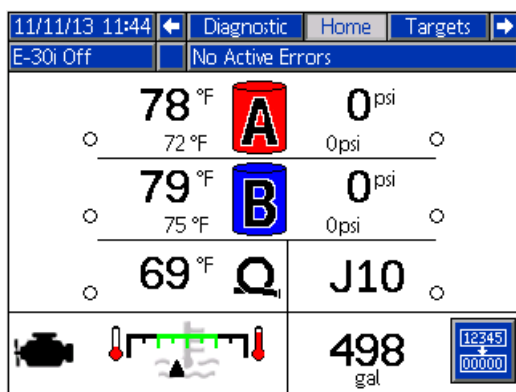

Home — System Active

When the system is active, the home screen displays actual temperature for heat zones, actual pressures at the fluid manifold, coolant temperature, jog speed, the number of cycles, along with all associated control soft keys.

Use this screen to turn on heat zones, view coolant temperature, start the proportioner, stop the proportioner, park the component A pump, enter jog mode, and clear cycles.

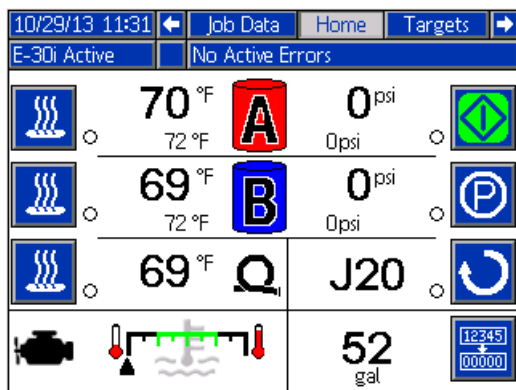

Home — System With Error

Active errors are shown in the status bar. The error code, alarm bell, and description of the error will scroll in the status bar.

1. Press  to acknowledge the error.
2. See [Troubleshoot Errors, page 72](#) for corrective action.



Targets

Use this screen to define the setpoints for the A Component Temperature, B Component Temperature, heated hose temperature, and pressure.

Maximum A and B temperature for systems without booster heat: 150°F (65°C)

Maximum A and B temperature for systems with booster heat: 180°F (82°C)

Maximum heated hose temperature: 10°F (5°C) above the highest A or B temperature setpoint or 180°F (82°C).

Note

If the remote display module kit is used, these setpoints can be modified at the gun.

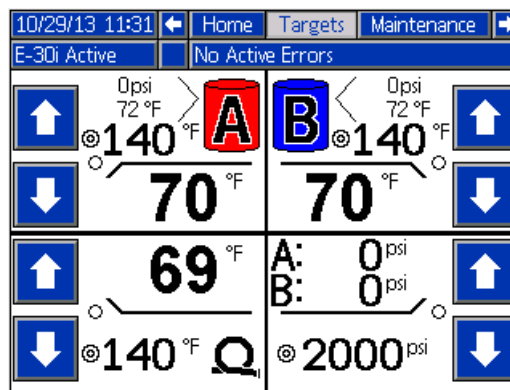

Operation

Maintenance

Use this screen to view daily and lifetime cycles or gallons that have been pumped and gallons or liters remaining in the drums.

The lifetime value is the number of pump cycles or gallons since the first time the ADM was turned on.

The daily value automatically resets at midnight.

The manual value is the counter that can be manually reset. Press  and hold to reset manual counter.

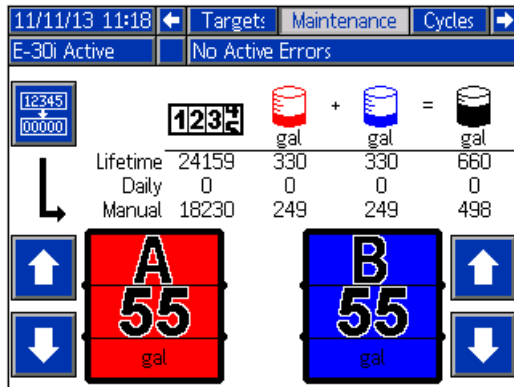

Cycles

This screen shows daily cycles and gallons that have been sprayed for the day.

All information listed on this screen can be downloaded on a USB flash drive.

Date	Cycles	Drum A (gal)	Drum B (gal)	Total (gal)
10/15/13	4	0	0	0
10/11/13	5248	72	72	144
10/10/13	760	10	10	20
10/09/13	378	5	5	10
10/02/13	767	10	10	20
--/--/--	650	9	9	18
09/30/13	1	0	0	0
09/27/13	649	9	9	18

Events

This screen shows the date, time, event code, and description of all events that have occurred on the system. There are 10 pages, each holding 10 events. The 100 most recent events are shown. See [System Events](#) for event code descriptions.

All events and errors listed on this screen can be downloaded on a USB flash drive. To download logs, see [Download Log Files, page 79](#).

Date	Time	Code	Description
10/29/13	11:32		
E-30i Active No Active Errors			
10/29/13	11:31	ECDP	Setpoint Changed Pressure
10/29/13	11:31	ECDH	Setpoint Changed Hose
10/29/13	11:31	ECDB	Setpoint Changed B
10/29/13	11:31	ECDA	Setpoint Changed A
10/29/13	11:30	EQU1	Sys. Settings Downloaded
10/29/13	11:30	EQU3	Custom Lang. Downloaded
10/29/13	11:30	EQU5	Logs Downloaded
10/29/13	11:30	EAUX	USB Busy
10/29/13	11:27	ELOX	System Power On
10/29/13	11:27	EMDX	System Power Off

System Events

Use the table below to find a description for all system non-error events. All events are logged in the USB log files.

Event Code	Description
EACX	Recipe Selected
EADA	Heat On A
EADB	Heat On B
EADH	Heat On Hose
EAPX	Pump On
EARX	Jog On
EAUX	USB Drive Inserted
EB0X	ADM Red Stop Button Pressed
EBDA	Heat Off A
EBDB	Heat Off B
EBDH	Heat Off Hose
EBPX	Pump Off
EBRX	Jog Off
EBUX	USB Drive Removed
EC0X	Setup Value Changed
ECDA	A Temperature Setpoint Changed
ECDB	B Temperature Setpoint Changed
ECDH	Hose Temperature Setpoint Changed
ECDP	Pressure Setpoint Changed
ECDX	Recipe Changed
EL0X	System Power On
EM0X	System Power Off
EP0X	Pump Parked
EQU1	System Settings Downloaded
EQU2	System Settings Uploaded
EQU3	Custom Language Downloaded
EQU4	Custom Language Uploaded
EQU5	Logs Downloaded
ER0X	User Counter Reset
EVUX	USB Disabled

Errors

This screen shows the date, time, error code, and description of all errors that have occurred on the system.

All errors listed on this screen can be downloaded on a USB flash drive.

Date	Time	Code	Description
10/29/13	11:26	CACT (E06)	Comm. Error TCM
10/29/13	11:26	CACM (E06)	Comm. Error MCM
10/28/13	09:52	T6DH (E04)	Sensor Err. Hose
10/15/13	06:30	V1MHLow	Voltage Hose
10/15/13	06:30	V1MBLow	Voltage B
10/15/13	06:30	V1MALow	Voltage A
10/15/13	06:30	H1MALow	Frequency A
10/15/13	06:30	H1MHLow	Frequency Hose
10/15/13	06:30	H1MBLow	Frequency B
10/14/13	15:01	V1MHLow	Voltage Hose

Job Data

Use this screen to enter a job name or number.

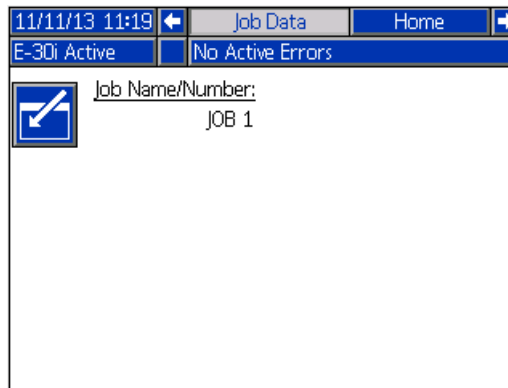

Recipes

Use this screen to add recipes, view saved recipes, and enable or disable saved recipes. Enabled recipes can be selected at the Home Run Screen. 24 recipes can be displayed on the three recipe screens.

	A	B	Q	psi	Enabled
RECIPE A	120	120	120	1100	<input checked="" type="checkbox"/>
RECIPE B	140	140	140	900	<input checked="" type="checkbox"/>
RECIPE C	32	32	32	500	<input type="checkbox"/>
RECIPE D	32	32	32	500	<input type="checkbox"/>
RECIPE E	32	32	32	500	<input type="checkbox"/>
RECIPE F	32	32	32	500	<input type="checkbox"/>
RECIPE G	32	32	32	500	<input type="checkbox"/>
RECIPE H	32	32	32	500	<input type="checkbox"/>

Startup

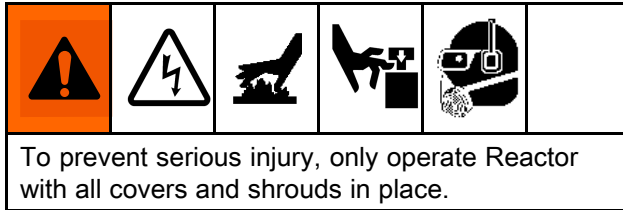

NOTICE

Proper system setup, startup, and shutdown procedures are critical to electrical equipment reliability. The following procedures ensure steady voltage. Failure to follow these procedures will cause voltage fluctuations that can damage electrical equipment and void the warranty.

1. Check generator fuel level.

Running out of fuel will cause voltage fluctuations that can damage electrical equipment.

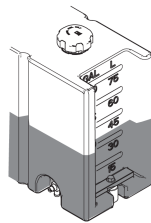

2. Check coolant levels.

Inspect the level of coolant inside the engine coolant expansion bottle (EB) and heat exchanger coolant expansion bottle (HB).

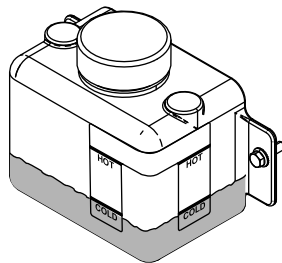

3. Check fluid inlet filter screens.

Before daily startup, ensure that the fluid inlet screens are clean. See [Flush Inlet Strainer Screen, page 75](#).

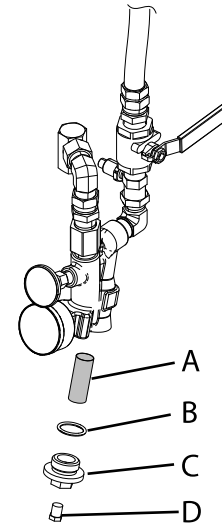

4. Check ISO lubrication reservoir.

Check level and condition of ISO lube daily. See [Pump Lubrication System, page 76](#).

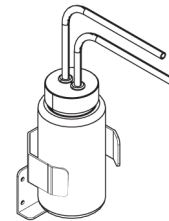

5. Use A and B Drum Level Sticks (24M174) to measure the material level in each drum. If desired, the level can be entered and tracked in the ADM. See [Advanced Setup Screens, page 50](#).
6. Confirm main power switch is OFF before starting generator.

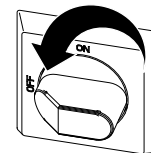

Startup

7. Press start button  on the engine control module twice to start the generator. Verify voltages are displayed on engine control module before moving to next step.

The controller will automatically begin glow plug warming and crank operations. Allow engine to reach full operating speed.

Note

Engine will not start if main power switch is in the ON position.

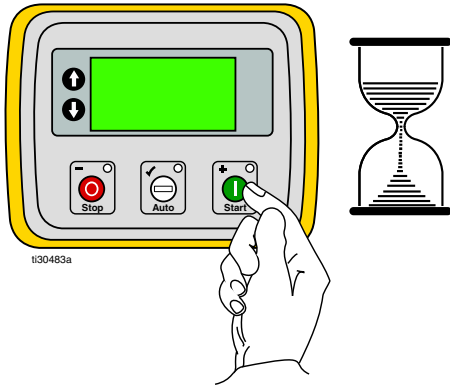

8. Turn main power switch ON.

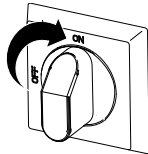

The ADM will display the following screen until communication and initialization is complete.



9. For first startup of new system, set system settings on ADM in Setup Mode.

See [Initial System Setup, page 47](#).

10. For first startup of new system, adjust air settings to zero:

- a. Close the main air shutoff valve (CK).

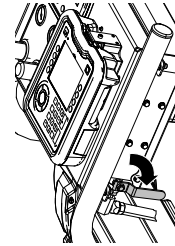

- b. Ensure all three air regulators are turned fully counterclockwise.

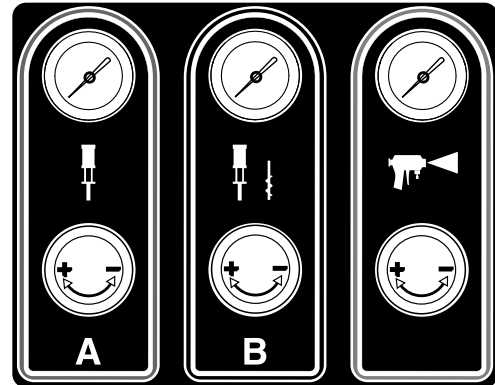

11. Start the air compressor, air dryer, breathing air, and other accessories. For systems with a supplied air compressor: start the air compressor by pressing start on the air compressor START box (CB).

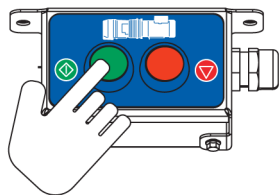

12. Open the main air shutoff valve (CK).

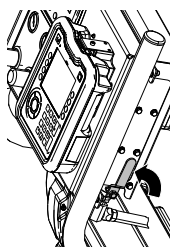

13. For first startup of new system, adjust all three air regulators to desired pressures.

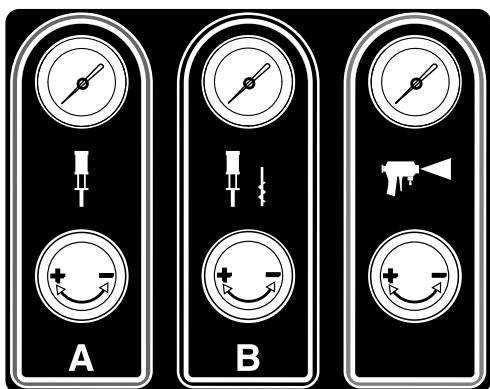

14. For first startup of new system, load fluid with feed pumps.
 - a. Check that all **Setup** steps are complete. See [Setup, page 37](#).
 - b. If an agitator is used, open the agitator's air inlet valve.
 - c. If you need to circulate fluid through the system to preheat the drum supply, see



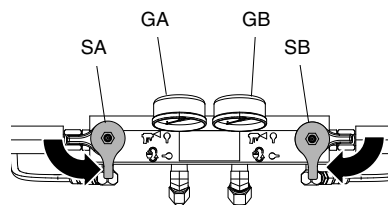

[Circulation Through Reactor, page 61](#).
If you need to circulate material through the heated hose to the gun manifold, see [Circulation Through Gun Manifold, page 62](#).

- d. Turn both PRESSURE RELIEF/SPRAY valves (SA, SB) to SPRAY .

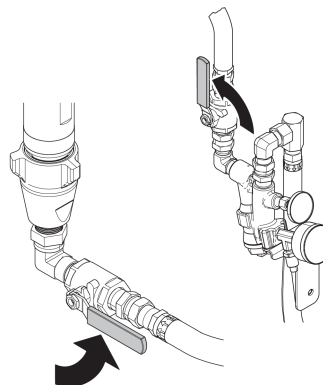

- e. Adjust A and B feed pump air regulators to desired air pressure, on front of proportioner, to start the feed pumps. Do not exceed 130 psi (0.2 MPa, 2 bar) to the A and B feed pumps.
- f. Open fluid inlet valves (FV). Check for leaks.



			
<p>Cross-contamination can result in cured material in fluid lines which could cause serious injury or damage equipment. To prevent cross-contamination:</p> <ul style="list-style-type: none"> • Never interchange component A and component B wetted parts. • Never use solvent on one side if it has been contaminated from the other side. <p>Always provide two grounded waste containers to keep component A and component B fluids separate.</p>			

Startup

- g. Hold gun fluid manifold over two grounded waste containers. Open fluid valves A and B until clean, air-free fluid comes from valves. Close valves.

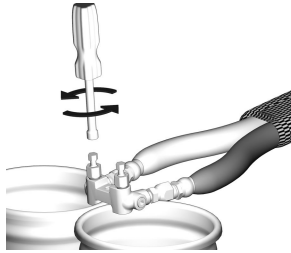







The Fusion AP gun manifold is shown.

- 15. Press  to activate the system.



- 16. Preheat the system:

				
<p>This equipment is used with heated fluid which can cause equipment surfaces to become very hot. To avoid severe burns:</p> <ul style="list-style-type: none"> • Do not touch hot fluid or equipment. • Do not turn on hose heat without fluid in hoses. • Allow equipment to cool completely before touching it. • Wear gloves if fluid temperature exceeds 110°F (43°C). 				

				
<p>Thermal expansion can cause overpressurization, resulting in equipment rupture and serious injury, including fluid injection. Do not pressurize system when preheating hose.</p>				

- a. Press  to turn on hose heat zone.

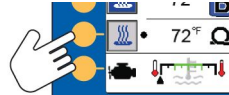

- b. Wait for the engine to reach operating temperature, indicated when the black arrow is under the green area of the temperature bar. The radiator fan will turn on when operating temperature is reached.

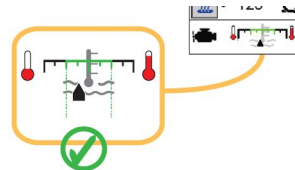

- c. Wait for the hose to reach set point temperature.

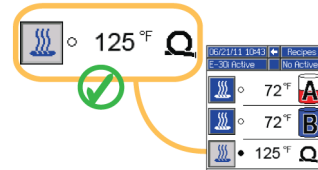

- d. Press  to turn on A and B heat zones.

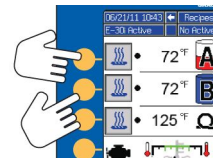

Fluid Circulation

Circulation Through Reactor





NOTICE
To prevent equipment damage, do not circulate fluid containing a blowing agent without consulting with your material supplier regarding fluid temperature limits.

Note

Optimum heat transfer is achieved at lower fluid flow rates with temperature set points at desired drum temperature. Low temperature rise deviation errors may result.

To circulate through gun manifold and preheat hose, see [Circulation Through Gun Manifold, page 62](#).



1. Follow [Startup, page 57](#).

				
To avoid injection injury and splashing, do not install shutoffs downstream of the PRESSURE RELIEF/SPRAY valve outlets (BA, BB). The valves function as overpressure relief valves when set to SPRAY  . Lines must be open so valves can automatically relieve pressure when machine is operating.				

2. See [Typical Installation, with circulation, page 15](#). Route circulation lines back to respective component A or B supply drum. Use hoses rated at the maximum working pressure of this equipment.

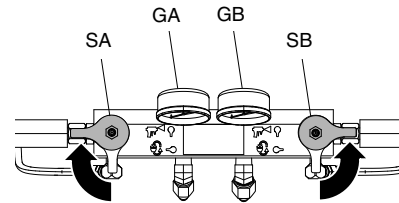
3. Set PRESSURE RELIEF/SPRAY valves (SA, SB) to PRESSURE RELIEF/CIRCULATION .



4. Set temperature targets. See [Targets, page 53](#).
5. Press  to circulate fluid in jog mode until A and B temperatures reach targets. See [Jog Mode, page 62](#) for more information about jog mode.
6. Press  to turn on the hose heat zone.
7. Turn on the A and B heat zones. Wait until the fluid inlet valve temperature gauges (FV) reach the minimum chemical temperature from the supply drums.
8. Exit jog mode.
9. Set PRESSURE RELIEF/SPRAY valves (SA, SB) to SPRAY .

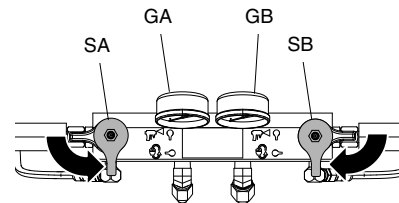

Circulation Through Gun Manifold

NOTICE

To prevent equipment damage, do not circulate fluid containing a blowing agent without consulting with your material supplier regarding fluid temperature limits.

Note

Circulating fluid through the gun manifold allows rapid preheating of the hose.

1. Install gun fluid manifold (P) on accessory circulation kit (CK). Connect high pressure circulation lines (R) to circulation manifold.

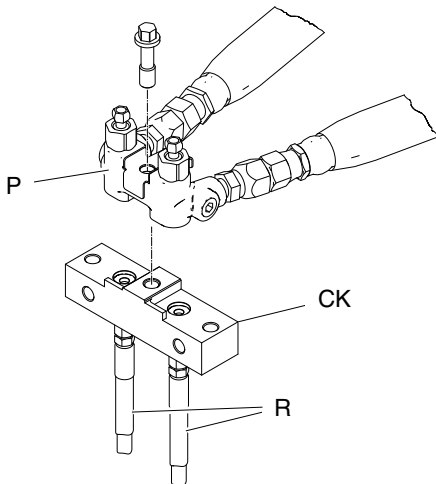

The Fusion AP gun manifold is shown.

CK	Gun	Manual
246362	Fusion AP	309818
256566	Fusion CS	313058

2. Route circulation lines back to respective component A or B supply drum. Use hoses

rated at the maximum working pressure of this equipment.

3. Follow procedures from [Startup, page 57](#).





4. Turn main power switch on
5. Set temperature targets. See [Targets, page 53](#).
6. Press  to circulate fluid in jog mode until A and B temperatures reach targets. See [Jog Mode, page 62](#) for more information about jog mode.

Jog Mode

Jog mode has two purposes:



- Speed fluid heating during circulation.
- Ease system flushing and priming.



1. Turn main power switch on
2. Press circulate  to enter jog mode.
3. Press up or down   to change jog speed (J1 through J20).

Note

Jog speeds correlate to 3-60% of motor speed, but will not operate over 700 psi (4.9 MPa, 49 bar) for either A or B.

4. Press  to start motor.
5. To stop the motor and exit jog mode press  or .

Spraying

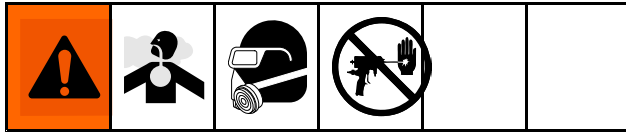

1. Engage gun piston safety lock and close gun fluid inlet valves A and B.

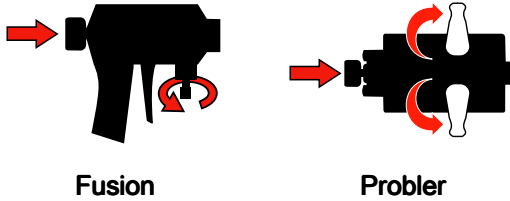

2. Attach gun fluid manifold. Connect gun air line. Open air line valve.

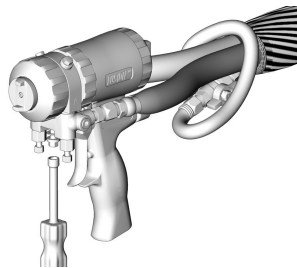

3. Adjust the gun air regulator on the proportioner control panel to desired gun air pressure. Do not exceed maximum rated air pressure.
4. Set PRESSURE RELIEF/SPRAY valves (SA, SB) to SPRAY

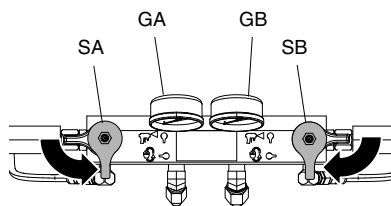

5. Check that heat zones are on and temperatures and pressures are on target, see [Home screen, page 53](#)

6. Verify that the engine temperature is at least up to the minimum operation temperature range. The fan will start running when the engine has reached maximum temperature.
7. Open fluid inlet valves.

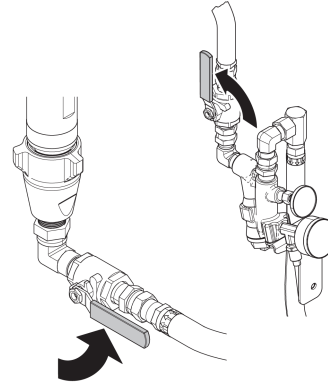

8. Press to start motor and pumps.

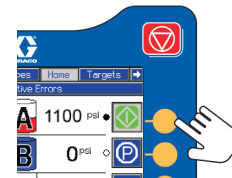

9. Check fluid pressure gauges (GA, GB) to ensure proper pressure balance. If imbalanced, reduce pressure of higher component by **slightly** turning PRESSURE RELIEF/SPRAY valve for that component toward PRESSURE

RELIEF/CIRCULATION until gauges show balanced pressures.

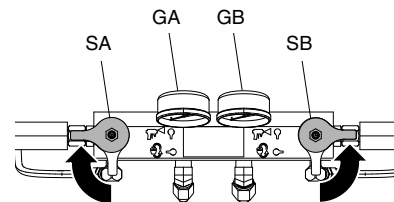

Spraying

10. Open gun fluid inlet valves A and B.

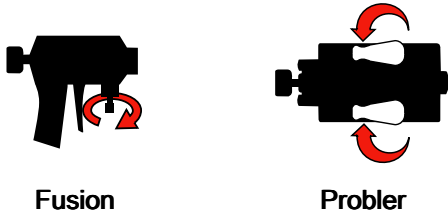

Fusion

Probler

NOTICE

To prevent crossover on impingement guns, **never** open fluid manifold valves or trigger gun if pressures are imbalanced.

11. Disengage gun piston safety lock.

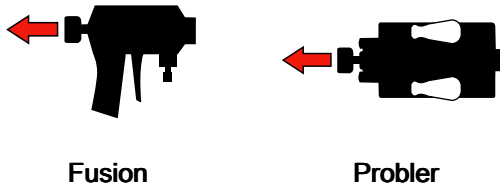

Fusion

Probler

12. Pull gun trigger to test spray onto cardboard. If necessary, adjust pressure and temperature to get desired results.

Spray Adjustments

Flow rate, atomization, and amount of overspray are affected by four variables.

- **Fluid pressure setting.** Too little pressure results in an uneven pattern, coarse droplet size, low flow, and poor mixing. Too much pressure results in excessive overspray, high flow rates, difficult control, and excessive wear.
- **Fluid temperature.** Similar effects to fluid pressure setting. The A and B temperatures can be offset to help balance the fluid pressure.
- **Mix chamber size.** Choice of mix chamber is based on desired flow rate and fluid viscosity.
- **Clean-off air adjustment.** Too little clean-off air results in droplets building up on the front of the nozzle, and no pattern containment to control overspray. Too much clean-off air results in air-assisted atomization and excessive overspray.

Manual Hose Heat Mode

If the system produces the T6DH sensor error hose alarm or the T6DT sensor error TCM alarm, use manual hose heat mode until the hose RTD sensor can be repaired.

Do not use Manual Hose Mode for extended periods of time. The system performs best when the hose has a valid RTD and can operate in temperature control mode. If a hose RTD breaks, the first priority is to fix the RTD. Manual Hose Mode can help finish a job while waiting for repair parts.

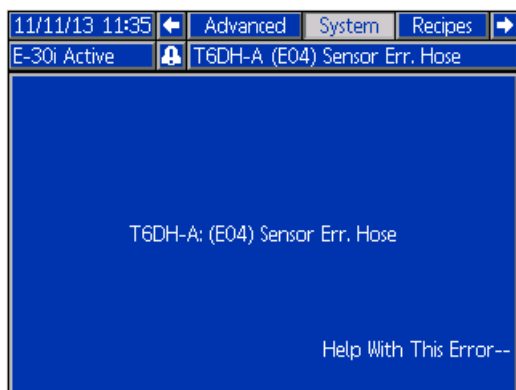

Enable Manual Hose Mode

1. Disconnect the hose RTD sensor from the TCM.
2. Enter Setup Mode and navigate to System Screen 2.

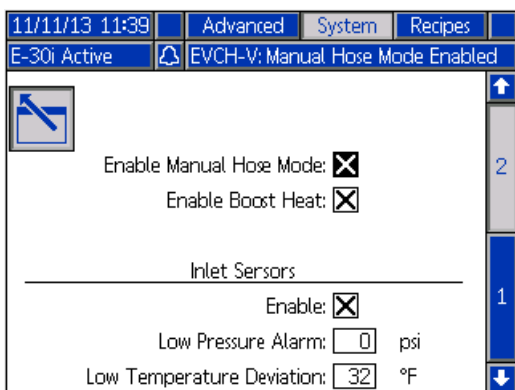

3. Select Enable Manual Hose Mode.

Note

When manual hose mode is enabled, the manual hose mode advisory EVCH-V will appear.

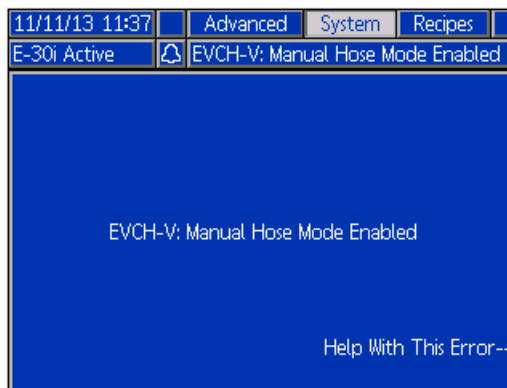

4. Enter Run Mode and navigate to the Target screen. Set the desired hose current.

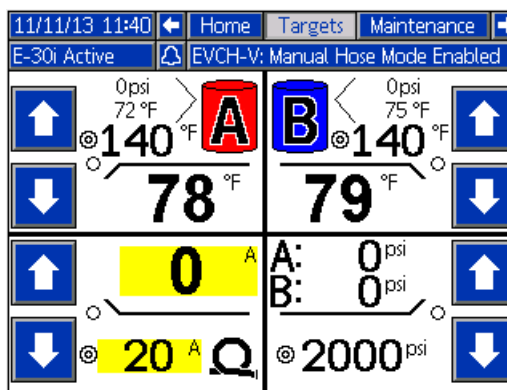

Hose Current Settings	Hose Current
Default	20A
Maximum	37A

Note

Until the RTD sensor is repaired, the T6DH sensor error alarm will display each time the system is powered up.

5. Navigate back to the Run Mode Home screen. The hose now displays a current instead of a temperature.

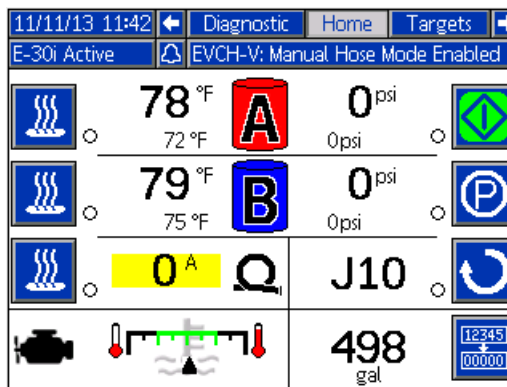

Disable Manual Hose Mode

1. Enter Setup Mode and navigate to System 2 Screen and deselect Enable Manual Hose Mode, or repair the hose RTD.

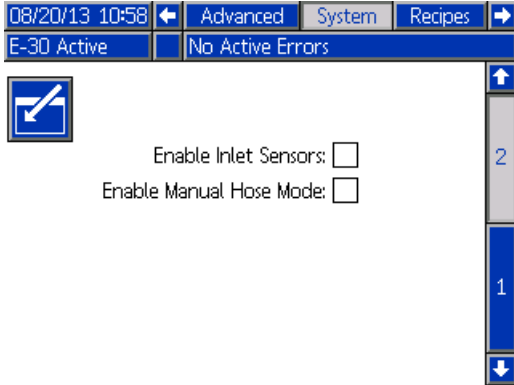

2. Manual hose mode is automatically disabled when the system detects a valid RTD sensor in the hose.

Shutdown

Immediate Shutdown

NOTICE

To avoid system damage, follow daily shutdown procedure. Use only for immediate shutdown.

For immediate shutdown, press:

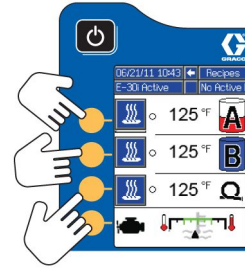
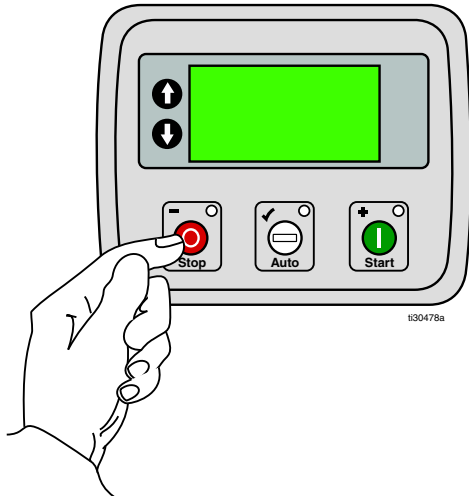

3. Set PRESSURE RELIEF/SPRAY valves (SA, SB) to PRESSURE RELIEF/CIRCULATION 

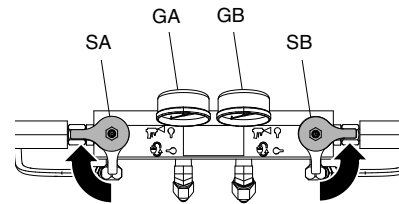

4. Relieve pressure. See [Pressure Relief Procedure, page 69](#).
5. Press  to park the Component A Pump. The park operation is complete when green dot goes out. Verify the park operation is complete before moving to next step.

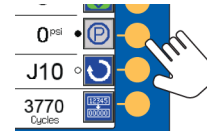

Daily Shutdown

NOTICE

Proper system setup, startup, and shutdown procedures are critical to electrical equipment reliability. The following procedures ensure steady voltage. Failure to follow these procedures will cause voltage fluctuations that can damage electrical equipment and void the warranty.

1. Press  to stop the pumps.

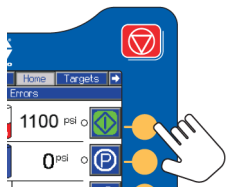

2. Turn off all heat zones.

6. Press  to deactivate the system.



7. Turn off the air compressor, air dryer, and breathing air.

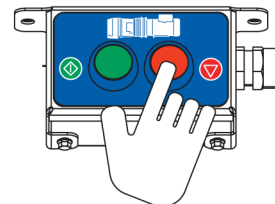

Shutdown

8. Close the main air shutoff valve.

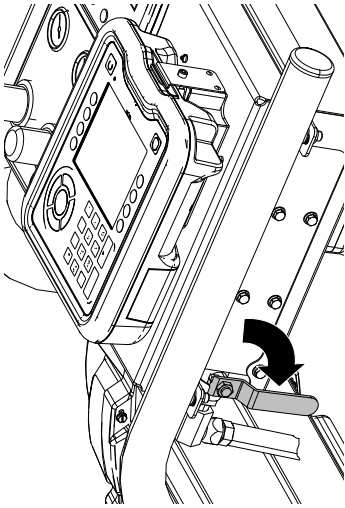

9. Turn main power switch OFF. Allow engine cooling dwell time prior to shutting down the engine.

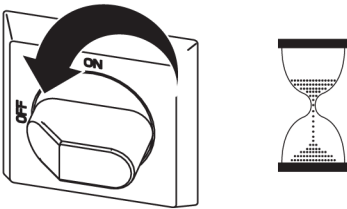

<p>To prevent electric shock do not remove any shrouds or open the electrical enclosure door. 240 V is still present in the system until the engine has stopped.</p>				

NOTICE

Allow engine cooling dwell time, per manufacturer recommendations, prior to shutdown. Dwell time will help engine properly cool down after running at operating temperature for any period of time. Stopping the engine immediately after running it at full load for an extended period of time can cause the engine to overheat due to the lack of coolant flow. See engine manual.

10. Press  to stop the engine.

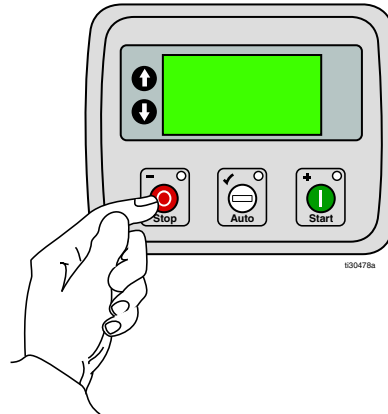

11. Close all fluid supply valves.

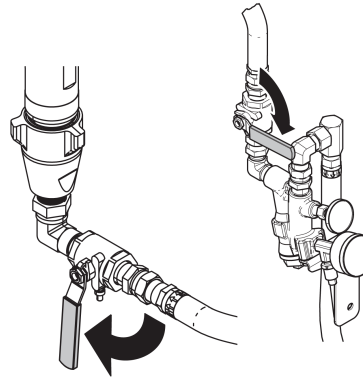

12. Set PRESSURE RELIEF/SPRAY valves (SA, SB) to SPRAY  to seal off moisture from drain lines.

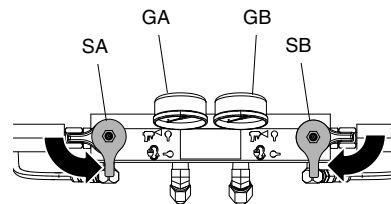

13. Engage gun piston safety lock then close fluid inlet valves A and B.

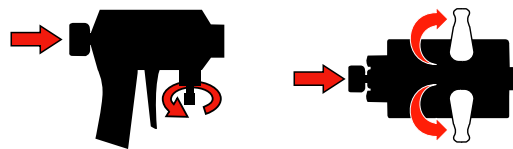

Fusion

Probler

Pressure Relief Procedure



Follow the Pressure Relief Procedure whenever you see this symbol.



This equipment stays pressurized until pressure is manually relieved. To help prevent serious injury from pressurized fluid, such as skin injection, splashing fluid and moving parts, follow the Pressure Relief Procedure when you stop spraying and before cleaning, checking, or servicing equipment.

The Fusion AP gun is shown.

1. Relieve pressure in gun and perform gun shutdown procedure. See gun manual.
2. Close gun fluid inlet valves A and B.

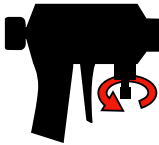

Fusion

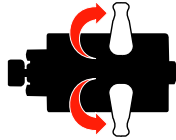

Probler

3. Shut off feed pumps and agitator, if used.

4. Route fluid to waste containers or supply tanks. Turn PRESSURE RELIEF/SPRAY valves (SA, SB) to PRESSURE RELIEF/CIRCULATION



Ensure gauges drop to 0.

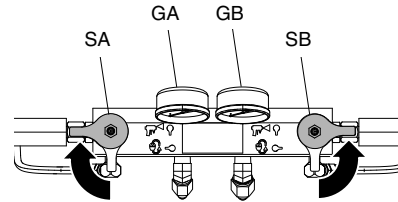

5. Engage gun piston safety lock.

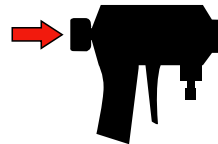

Fusion



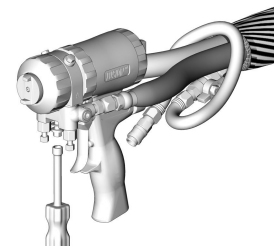

Probler

6. Disconnect gun air line and remove gun fluid manifold.



Flushing

					
<p>To help prevent fire and explosion:</p> <ul style="list-style-type: none">• Flush equipment only in a well-ventilated area.• Do not spray flammable fluids.• Do not turn on heaters while flushing with flammable solvents.• Flush out old fluid with new fluid, or flush out old fluid with a compatible solvent before introducing new fluid.• Use the lowest possible pressure when flushing.• All wetted parts are compatible with common solvents. Use only moisture-free solvents.					

To flush feed hoses, pumps, and heaters separately from heated hoses, set PRESSURE RELIEF/SPRAY valves (SA, SB) to PRESSURE

RELIEF/CIRCULATION . Flush through bleed lines (N).

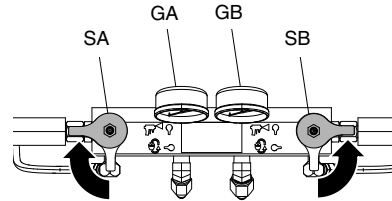

To flush entire system, circulate through gun fluid manifold (with manifold removed from gun).

To prevent moisture from reacting with isocyanate, always leave the system filled with a moisture-free plasticizer or oil. Do not use water. Never leave the system dry. See [Important Isocyanate Information](#).



System Errors

System errors alert you of a problem and help prevent off-ratio spraying. When an error occurs the error information screen displays the active error code and description.

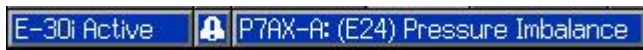
The error code, alarm bell, and active errors will scroll in the status bar. For a list of the ten most recent errors see [Errors, page 56](#).



There are three types of errors that can occur. Errors are indicated on the display as well as by the light tower (optional).

Error	Description
Alarms 	A parameter critical to the process has reached a level requiring the system to stop. The alarm needs to be addressed immediately.
Deviations 	A parameter critical to the process has reached a level requiring attention, but not sufficient enough to stop the system at this time.
Advisories 	A parameter that is not immediately critical to the process. The advisory needs attention to prevent more serious issues in the future.

To troubleshoot the active error, see [Troubleshoot Errors, page 72](#). See system repair manual for non-error based troubleshooting.

Troubleshoot Errors

See system repair manual or visit help.graco.com for causes and solutions to each error code.

To troubleshoot the error:

1. Press the soft key next to “Help With This Error” for help with the active error.

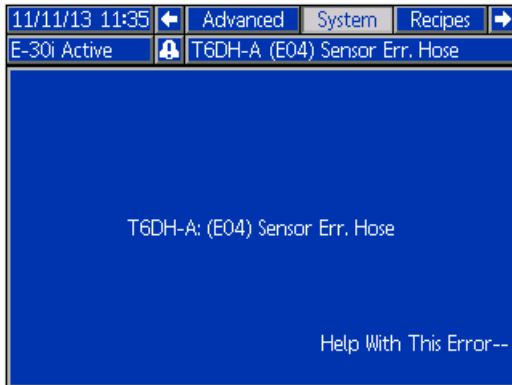

2. The QR code screen will be displayed. Scan the QR code with your mobile device to be sent directly to online troubleshooting for the active error code. Otherwise, manually navigate to help.graco.com and search for the active error.



Note

Press  or  to return to the previously displayed screen.

3. If no internet connection is available, see Error Code Troubleshooting in the system repair manual for causes and solutions for each error code.

Clear Alarm

When a deviation or alarm occurs, be sure to determine the error code before resetting it.

Note

If you forget which code occurred, go to [Errors, page 56](#), to view the last 200 errors with date and time stamps.

If an alarm has occurred, correct the cause before resuming operation. For error code troubleshooting, see [Troubleshoot Errors, page 72](#).

To acknowledge a deviation or clear an alarm, press



Maintenance



Prior to performing any maintenance procedures, follow [Pressure Relief Procedure, page 69](#).

Preventative Maintenance Schedule

The operating conditions of your particular system determine how often maintenance is required. Establish a preventive maintenance schedule by recording when and what kind of maintenance is needed, and then determine a regular schedule for checking your system.

Wetcup

Check the wet cup daily. Keep it 2/3 full with Graco Throat Seal Liquid (TSL®) or compatible solvent. Do not overtighten packing nut/wet cup.

Fluid Inlet Strainer Screen

Inspect fluid inlet strainer screens daily, see [Flush Inlet Strainer Screen, page 75](#).

Coolant Filter

Inspect filter in coolant filter housing monthly. Replace filter semi-annually. See Repair manual.

Grease Circulation Valves

Grease circulation valves (SA, SB) with Fusion grease (117773) weekly.

ISO Lubrication Level

Inspect ISO lubricant level and condition daily. Refill or replace as needed. See [Pump Lubrication System, page 76](#).

Wiring Connections

Tighten all screw-type wiring connections in the Electrical Enclosure (DB), Reactor cabinet, and air compressor control box (if supplied) monthly.

Dust Protection

Use clean, dry, oil-free compressed air to prevent dust buildup on control modules, control boards, fans, and motor (under shield).

Coolant Levels

Check coolant level inside both overflow tanks daily.

Flush and refill the coolant on both the engine and heat exchanger coolant loop once a year. See system repair manual for instructions.

Compressor Maintenance

Check that the oil level is visible in sight glass weekly. Use only Hydrovane approved oil such as Hydrovane Fluid Force Red 2000 oil or CompAir CS-300. One gallon container (17A101) is available as an accessory.

Refer to the Hydrovane User Handbook for all service schedule information.

Every 2000 hours or 1 year: Change oil and install Hydrovane kit KO52 (includes air filter and two gaskets).

Every 4000 hours: Change oil and install Hydrovane Kit KM52 (includes air filter, oil separator and miscellaneous seals).

Every 10000 hours: Hydrovane Top-Up kit KT53 (recommended for a complete rebuild completed by a Hydrovane Service Center).

Air Compressor Oil Level

- Daily check air compressor oil level through sight glass.

Clean Heat Sink Fins

Keep heat sink fins clean at all times. Clean them using a dry cloth or compressed air.

Note

Do not use conductive cleaning solvents on the module.

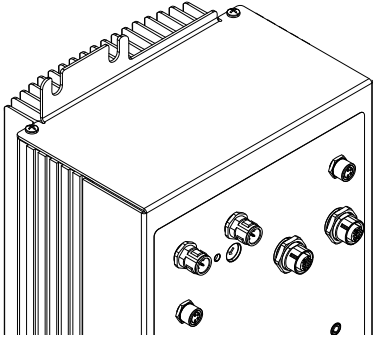

Figure 32 MCM Heat Fins

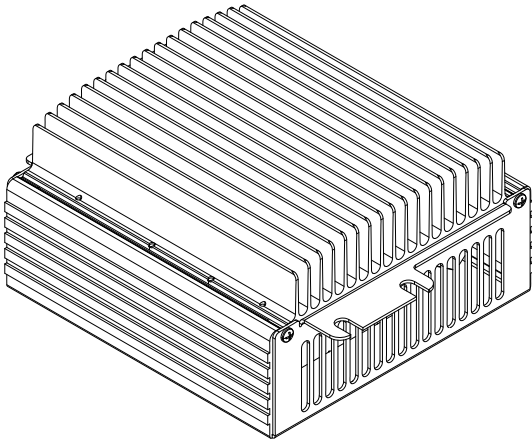

Figure 33 TCM Fins

Air Dryer Water Separator

- Clean ambient air filter monthly or more often if air flow across the condenser is blocked.
- Clean inlet strainer monthly or more often if rapid clogging occurs.
- Replace separator/filter element yearly or more often if pressure drop across the dryer is excessive.
- Check automatic condensate drain daily.

Engine Maintenance

The engine instructions that accompany your unit detail specific procedures for maintenance of the engine. Following the engine manufacturer's recommendations will extend engine work life.

Daily

- Cooling System Coolant Level — Check
- Engine Air Cleaner Service Indicator — Inspect
- Engine Oil Level — Check

Every 500 Service Hours or 1 Year

- Engine Air Cleaner Element (Dual Element) — Clean/Replace
- Engine Oil and Filter — Change
- Fuel System Filter — Replace
- Battery Voltage — Check. See [Appendix A: Engine Control Module, page 81](#).

Contact an Authorized Perkins Dealer or Distributor for replacement filter elements. Refer to Perkins engine part number GN66141N for compatible parts.

Fuel Tank

Fuel quality is critical to the performance and to the service life of the engine. Water in the fuel tank can cause excessive wear to the fuel system. See the supplied Perkins engine manual for fuel tank maintenance recommendations.

Flush Inlet Strainer Screen



The inlet strainers filter out particles that can plug the pump inlet check valves. Inspect the screens daily as part of the startup routine, and clean as required.

Isocyanate can crystallize from moisture contamination or from freezing. If the chemicals used are clean and proper storage, transfer, and operating procedures are followed, there should be minimal contamination of the A-side screen.

Note

Clean the A-side screen only during daily startup. This minimizes moisture contamination by immediately flushing out any isocyanate residue at the start of dispensing operations.

1. Close the fluid inlet valve at the pump inlet and shut off the appropriate feed pump. This prevents material from being pumped while cleaning the screen.
2. Place a container under the strainer base to catch drain off when removing the strainer plug (C).

3. Remove the screen (A) from the strainer manifold. Thoroughly flush the screen with compatible solvent and shake it dry. Inspect the screen. No more than 25% of the mesh should be restricted. If more than 25% of the mesh is blocked, replace the screen. Inspect the gasket (B) and replace as required.
4. Ensure the pipe plug (D) is screwed into the strainer plug (C). Install the strainer plug with the screen (A) and gasket (B) in place and tighten. Do not overtighten. Let the gasket make the seal.
5. Open the fluid inlet valve, ensure that there are no leaks, and wipe the equipment clean. Proceed with operation.

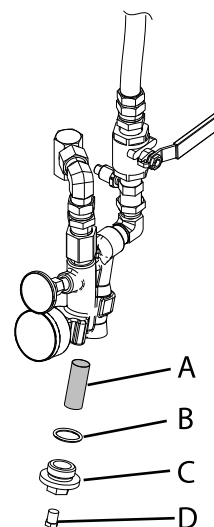

Figure 34

Pump Lubrication System

Check the condition of the ISO pump lubricant daily. Change the lubricant if it becomes a gel, its color darkens, or it becomes diluted with isocyanate.

Gel formation is due to moisture absorption by the pump lubricant. The interval between changes depends on the environment in which the equipment is operating. The pump lubrication system minimizes exposure to moisture, but some contamination is still possible.

Lubricant discoloration is due to continual seepage of small amounts of isocyanate past the pump packings during operation. If the packings are operating properly, lubricant replacement due to discoloration should not be necessary more often than every 3 or 4 weeks.

To change pump lubricant:

1. Follow [Pressure Relief Procedure, page 69](#).
2. Lift the lubricant reservoir (R) out of the bracket and remove the container from the cap. Holding the cap over a suitable container, remove the check valve and allow the lubricant to drain. Reattach the check valve to the inlet hose.
3. Drain the reservoir and flush it with clean lubricant.
4. When the reservoir is flushed clean, fill with fresh lubricant.
5. Thread the reservoir onto the cap assembly and place it in the bracket.
6. The lubrication system is ready for operation. No priming is required.

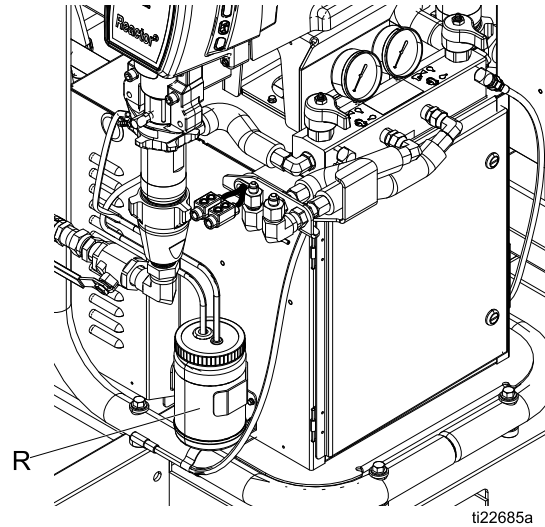

Pump Lubrication System
Figure 35

USB Data

Each time a USB flash drive is inserted into the ADM USB port, a new folder named DATAxxxx is created. The number at the end of the folder name increases each time a USB flash drive is inserted and data is downloaded or uploaded.

Note

The ADM can read/write to FAT (File Allocation Table) storage devices. NTFS, used by 32 GB or greater storage devices, is not supported.

USB Logs

During operation, the ADM stores system and performance related information to memory in the form of log files. The ADM maintains four log files:

- Event Log
- Job Log
- Daily Log
- System Software Log
- Blackbox Log
- Diagnostics Log

Follow [Download Procedure, page 79](#), to retrieve log files.

Event Log

The event log file name is 1–EVENT.CSV and is stored in the DATAxxxx folder.

The event log maintains a record of the last 49,000 events and errors. Each event record contains:

- Date of event code
- Time of event code
- Event code
- Event type
- Action taken
- Event Description

Event codes include both error codes (alarms, deviations, and advisories) and record only events.

Actions Taken includes setting and clearing event conditions by the system, and acknowledging error conditions by the user.

Job Log

The job log file name is 2–JOB.CSV and is stored in the DATAxxxx folder.

The job log maintains a record of data points based on the USB Log Frequency defined in the Setup screens. The ADM stores the last 237,000 data points for download. See [Setup - Advanced Screen 3 — USB, page 50](#), for information on setting the Download Depth and USB Log Frequency.

- Data point date
- Data point time
- A side heat exchanger temperature
- A side boost heater temperature
- B side heat exchanger temperature
- B side boost heater temperature
- Hose temperature
- Engine coolant temperature
- A side temperature setpoint
- B side temperature setpoint
- Hose temperature setpoint
- Inlet A side pressure
- Inlet B side pressure
- Pressure setpoint
- System lifetime pump cycle counts
- Pressure, volume, and temperature units
- Job name/number

Daily Log

The daily log file name is 3–DAILY.CSV and is stored in the DATAxxxx folder.

The daily log maintains a record of the total cycle and volume sprayed on any day that the system is powered up. The volume units will be the same units that were used in the Job Log.

The following data is stored in this file:

- Date that material was sprayed
- Time — unused column
- Total pump cycle count for day
- Total volume sprayed for day

System Software Log

The system software file name is 4–SYSTEM.CSV and is stored in the DATAxxxx folder.

The system software log lists the following:

- Date log was created
- Time log was created
- Component name
- Software version loaded on the above component

Blackbox Log File

The black box file name is 5–BLACKB.CSV and is stored in the DATAxxxx folder.

The Blackbox log maintains a record of how the system runs and the features that are used. This log will help Graco troubleshoot system errors.

Diagnostics Log File

The diagnostics file name is 6–DIAGNO.CSV and is stored in the DATAxxxx folder.

The Diagnostics log maintains a record of how the system runs and the features that are used. This log will help Graco troubleshoot system errors.

System Configuration Settings

The system configuration settings file name is SETTINGS.TXT and is stored in the DOWNLOAD folder.

A system configuration settings file automatically downloads each time a USB flash drive is inserted into the ADM. Use this file to back up system settings for future recovery or to easily replicate settings across multiple systems. Refer to the [Upload Procedure, page 80](#) for instructions on how to use this file.

Download Log Files

Note

System configuration setting files and custom language files can be modified if the files are in the UPLOAD folder of the USB flash drive. See System Configuration Settings File, Custom Language File, and Upload Procedure sections.

Note

If needed, set the number of days to download on the Advanced Setup Screen 3–USB in the ADM. USB log frequency can only be changed before logging occurs.

1. Insert USB flash drive into USB port.
2. The menu bar and USB indicator lights “USB Busy” to indicate that the USB is downloading files. USB activity is complete when the “USB Busy” screen prompt disappears or the flash drive LED stops flashing.

Note

Normal system spraying can continue while download is in progress.
3. Remove USB flash drive from USB port.
4. Insert USB flash drive into USB port of computer.
5. The USB flash drive window automatically opens. If it does not, open USB flash drive from within Windows® Explorer.
6. Open GRACO folder.
7. Open the system folder. If downloading data from more than one system, there will be more than one folder. Each folder is labeled with the corresponding serial number of the ADM (The serial number is on the back of the ADM.)
8. Open DOWNLOAD folder.

9. Open DATAxxxx folder.
10. Open DATAxxxx folder labeled with the highest number. The highest number indicates the most recent data download.
11. Open log file. Log files open in Microsoft® Excel by default as long as the program is installed. However, they can also be opened in any text editor or Microsoft® Word.

Note

All USB logs are saved in Unicode (UTF-16) format. If opening the log file in Microsoft Word, select Unicode encoding.

Custom Language File

The custom language file name is DISPTEXT.TXT and is stored in the DOWNLOAD folder.

A custom language file automatically downloads each time a USB flash drive is inserted into the ADM. If desired, use this file to create a user-defined set of custom language strings to be displayed within the ADM.

The system is able to display the following Unicode characters. For characters outside of this set, the system will display the Unicode replacement character, which appears as a white question mark inside of a black diamond.

- U+0020 - U+007E (Basic Latin)
- U+00A1 - U+00FF (Latin-1 Supplement)
- U+0100 - U+017F (Latin Extended-A)
- U+0386 - U+03CE (Greek)
- U+0400 - U+045F (Cyrillic)

Create Custom Language Strings

The custom language file is a tab-delimited text file that contains two columns. The first column consists of a list of strings in the language selected at the time of download. The second column can be used to enter the custom language strings. If a custom language was previously installed, this column contains the custom strings. Otherwise the second column is blank.

Modify the second column of the custom language file as needed and then follow [Upload Procedure, page 80](#), to install the file.

The format of the custom language file is critical. The following rules must be followed in order for the installation process to succeed.

- Define a custom string for each row in the second column.

Note

If the custom language file is used, you must define a custom string for each entry in the DISPTXT.TXT file. Blank second-column fields will be displayed blank on the ADM.

- The file name must be DISPTXT.TXT.
- The file format must be a tab-delimited text file using Unicode (UTF-16) character representation.
- The file must contain only two columns, with columns separated by a single tab character.
- Do not add or remove rows to the file.
- Do not change the order of the rows.

Upload Procedure

Use this procedure to install a system configuration file and/or a custom language file.

1. If necessary, follow the **Download Procedure** to automatically generate the proper folder structure on the USB flash drive.
2. Insert USB flash drive into USB port of computer.
3. The USB flash drive window automatically opens. If it does not, open USB flash drive from within Windows Explorer.
4. Open GRACO folder.
5. Open the system folder. If working with more than one system, there will be more than one folder within the GRACO folder. Each folder is labeled with the corresponding serial number of the ADM. (The serial number is on the back of the module.)
6. If installing the system configuration settings file, place SETTINGS.TXT file into the UPLOAD folder.
7. If installing the custom language file, place DISPTXT.TXT file into the UPLOAD folder.
8. Remove USB flash drive from the computer.
9. Install USB flash drive into the ADM USB port.
10. The menu bar and USB indicator lights indicate that the USB is downloading files. Wait for USB activity to complete.
11. Remove USB flash drive from USB port.

Note

If the custom language file was installed, users can now select the new language from the Language drop-down menu in [Advanced Screen 1 — General, page 50](#).



Appendix A: Engine Control Module

General information for Engine Control Module on system series "C" and following

Run Screens

There are ten run screens on the engine control module:









- Line-to-Neutral Voltage
- Line-to-Line Voltage
- Frequency
- Engine Speed
- Engine Lifetime Counter
- Battery Voltage
- Charging Voltage
- Time and Date
- Engine Control Module Information
- Engine Control Module Software Information



Press  (up) or  (down) to scroll through the run screens.

Run Screen Layout

Inst Icon	Instrumentation	Units	Alarm Icon
			Mode Icon
Load Switching Icons (not used)			

Information Screens

From the Run Screen, press and release  (up) and  (down) together to enter the screen selection mode. Press  and  to highlight the  (event log) icon, then press  (Auto) to enter the event log. Press  or  to scroll through the last fifty generator events.

To return to the Run Screens, press and release  and  together, highlight the home icon, and press the  home icon, and press .

Information Screen Layout



	Time of Event (Engine Run Hours)	Units	Alarm Icon
Event #			Mode Icon
Load Switching Icons (not used)			

General information for Engine Control Module on system series “A” and “B” only

Run Screens

There are seven run screens on the engine control module:



- Line-to-Neutral Voltage
- Line-to-Line Voltage
- Frequency
- Engine Speed
- Engine Lifetime Counter
- Battery Voltage

Press  (down) to scroll through the run screens. Press  to enter the Information screens.

Run Screen Layout

Inst Icon	Instrumentation	Units	Alarm Icon
			Mode Icon

Information Screens





From the Run Screen, press  to enter the information screens. Press  to scroll through the last five generator events.

Press  to return to the Run Screens.

	Time of Event (Engine Run Hours)	Units	Alarm Icon
Event #			Mode Icon







Mode Icons

Applies to engine control modules on all systems series.

Icon	Description	Details
	Stopped	Engine is at rest and the unit is in stop mode.
	Auto	The unit is in auto mode (not used).
	Manual	Engine is at rest and the unit is in manual run mode.
	Timer animation	Engine is starting up.
	Running animation	Engine is running.

Instrumentation Icons

A small icon is displayed in the instrumentation icon area to indicate what value is currently being displayed. Applies to engine control modules on all system series unless noted otherwise.

Icon	Description	Details
	Generator	Generator voltage and frequency screen
	Engine Speed	Engine speed screen
	Engine Lifetime Counter	Hours run
	Event Log	Event is being displayed.
	Unit Time	Unused feature
	Battery	Battery voltage
	Charge Alternator	Charging voltage screen (system series "C" and following only)

Alarms

The following information applies to engine controllers on all system series unless noted otherwise. There are two types of alarms that can occur on the engine control module. Alarms are indicated by an icon on the Run and Information screens. See the information screen to view recent alarms.





Warning

When present on system, a warning alarm will not stop the generator.

Shutdown







When present on system, a shutdown alarm will stop the generator.

Warning

Icon	Description	Details
	Battery High Voltage	The DC Supply has risen above the high volts setting level for the duration of the high battery volts timer.
	Battery Low Voltage	The DC Supply has fallen below the low volts setting level for the duration of the low battery volts timer.
	Fail To Stop	The module detected a condition that indicates that the engine is running when it has been instructed to stop. NOTE: this warning could indicate a faulty oil pressure sensor or related wiring.
	Flexible Sensor	The flexible sensor warning alarm has been triggered.
	Charge Failure	The charge alternator voltage is low (system series "C" and following only).

Shutdown

Remove the fault. Then press the stop button to reset the engine control module.

Icon	Description	Details
	Fail To Start	The engine has not reached operating speed or the oil pressure has not risen after attempting to start.
	Generator High Voltage Shutdown	The generator output voltage has risen above the preset level.
	Generator Low Voltage Shutdown	The generator output voltage has fallen below the preset level.
	High Coolant Temperature Shutdown	The module detects that the engine coolant temperature has exceeded the high engine temperature shutdown setting after the Safety On Start-up timer has expired.
	Low Oil Pressure Shutdown	The engine oil pressure has fallen below the low oil pressure trip setting level after the Safety On Start-up timer has expired.
	Over Frequency Shutdown	The generator output frequency has risen above the preset level.
	Under Frequency Shutdown	The generator output frequency has fallen below the preset level.

Dimensions

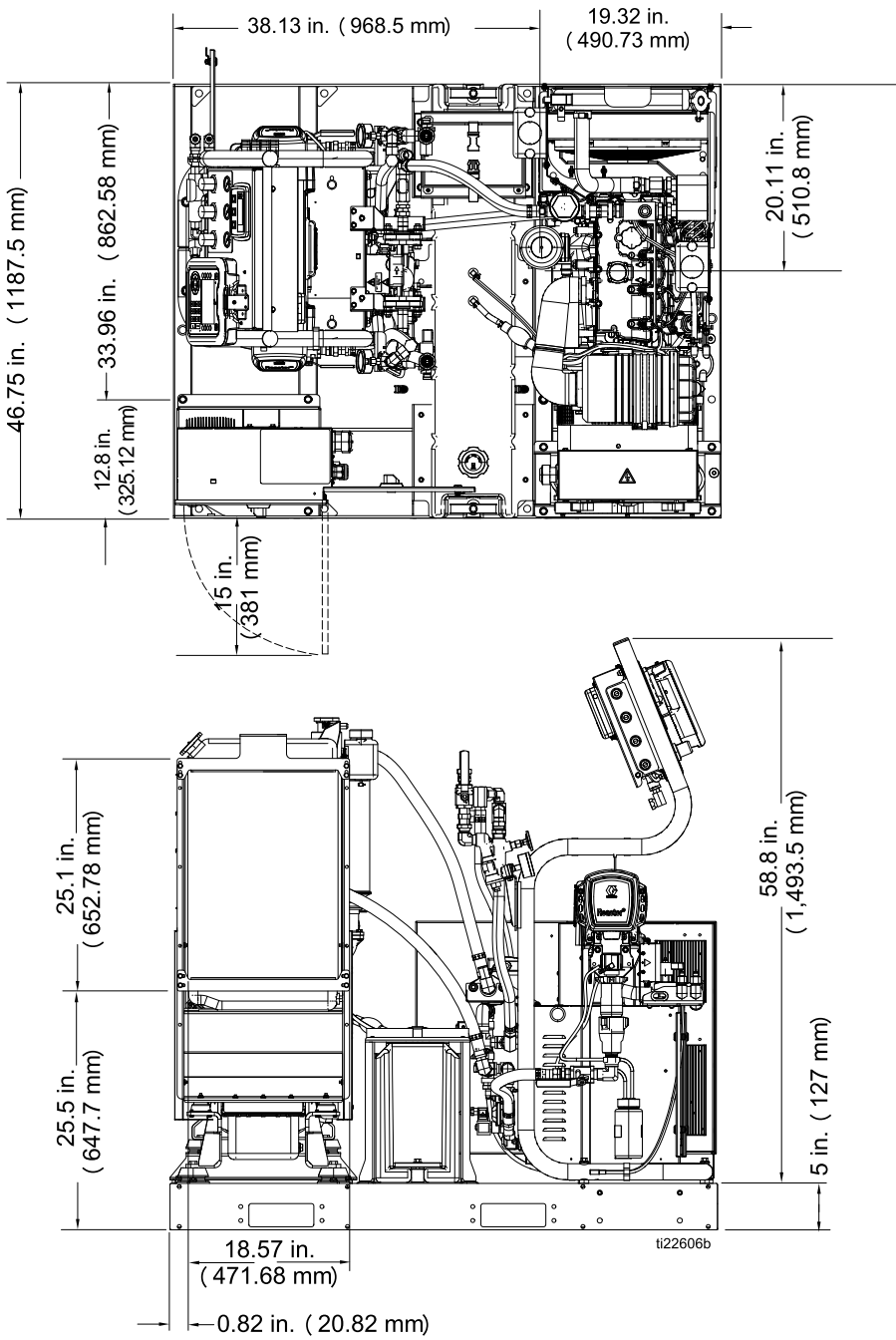

Figure 36

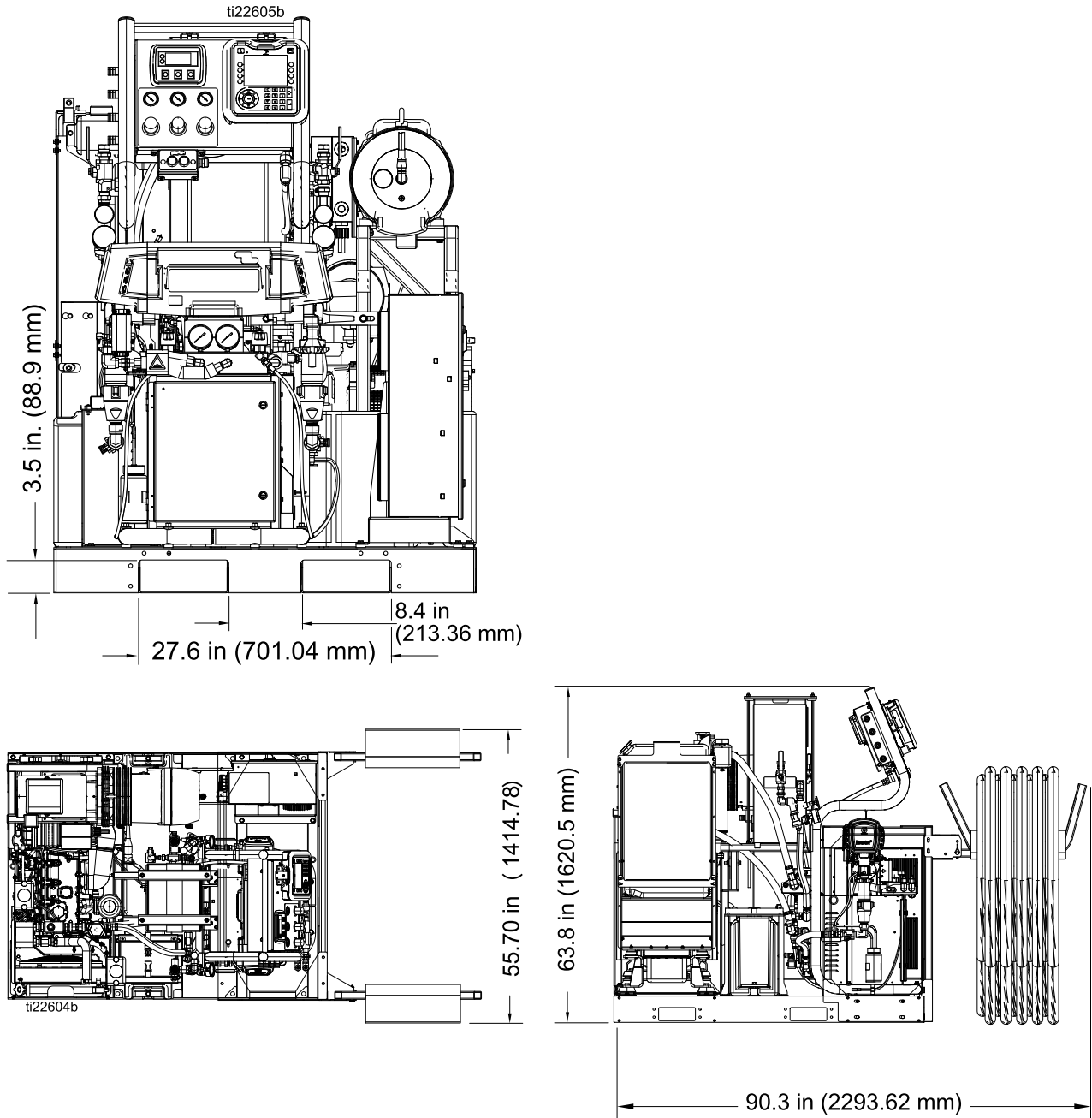
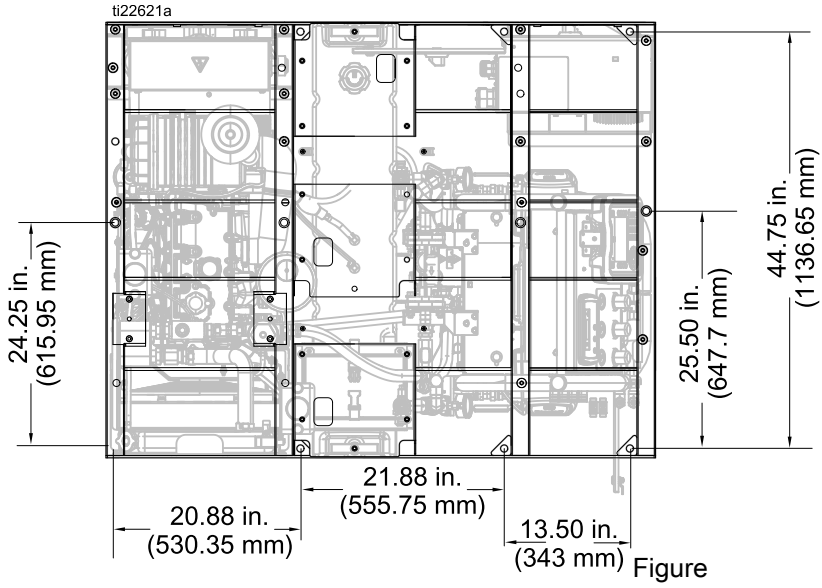

Figure 37

Dimensions



38 Floor Mount Hole Pattern

Performance Charts

Use these charts to help identify the proportioner that will work most efficiently with each mix chamber. Flow rates are based on a material viscosity of 60 cps.

NOTICE

To prevent system damage, do not pressurize the system above the line for the gun tip size being used.

Proportioners For Foam

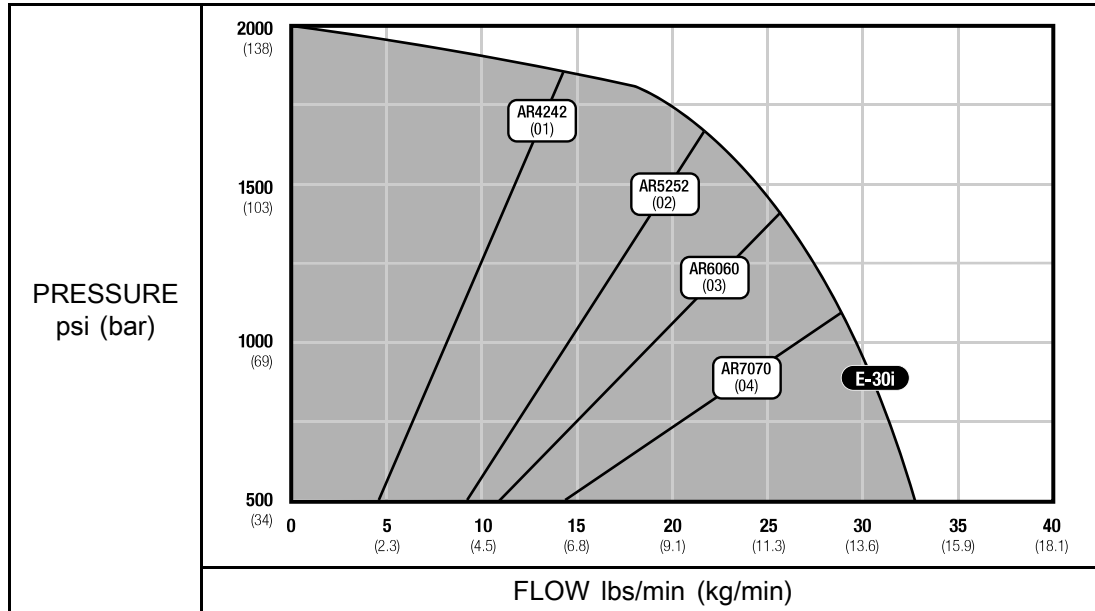

Proportioners For Coatings

Table 4 Fusion Air Purge, Round Pattern

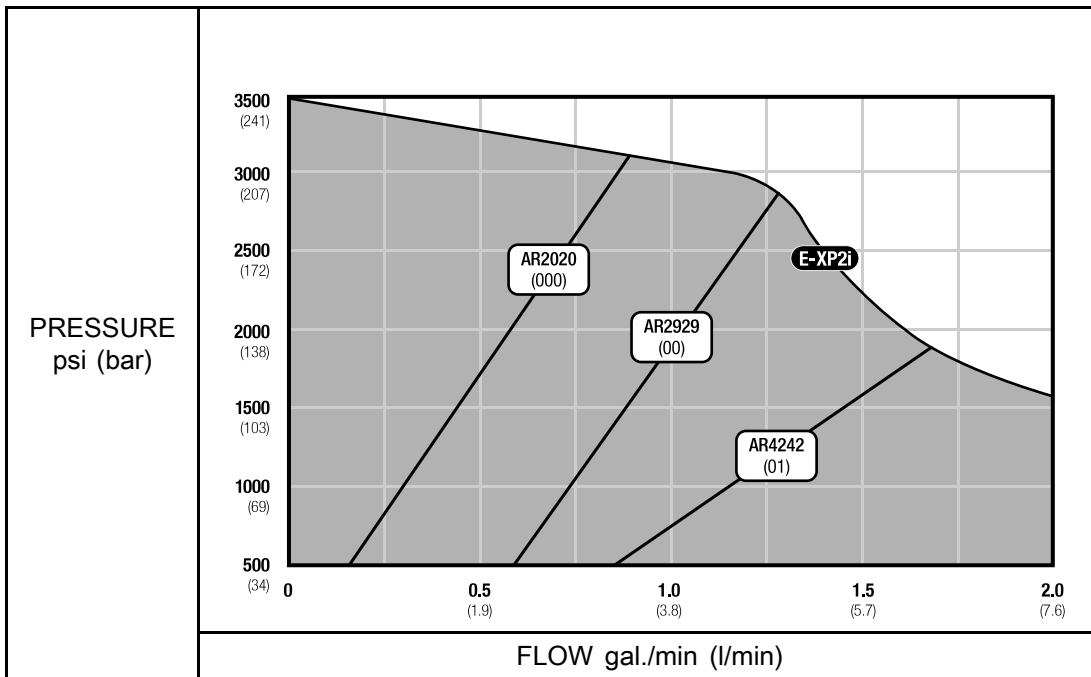

Table 5 Fusion Air Purge, Flat Pattern

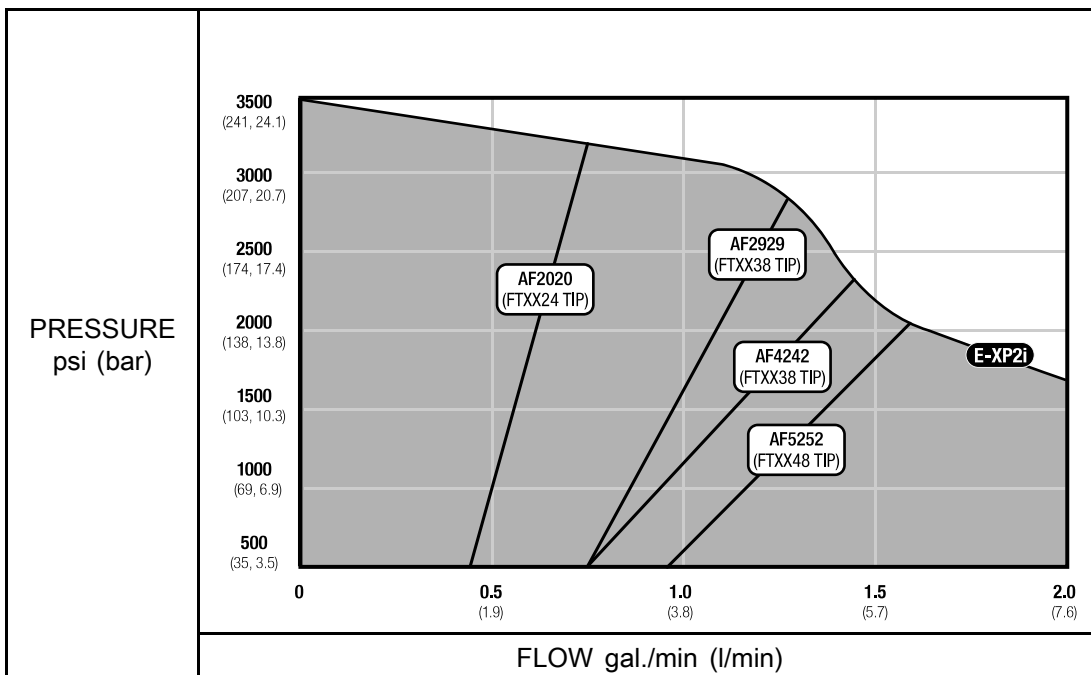

Table 6 Fusion Mechanical Purge, Round Pattern

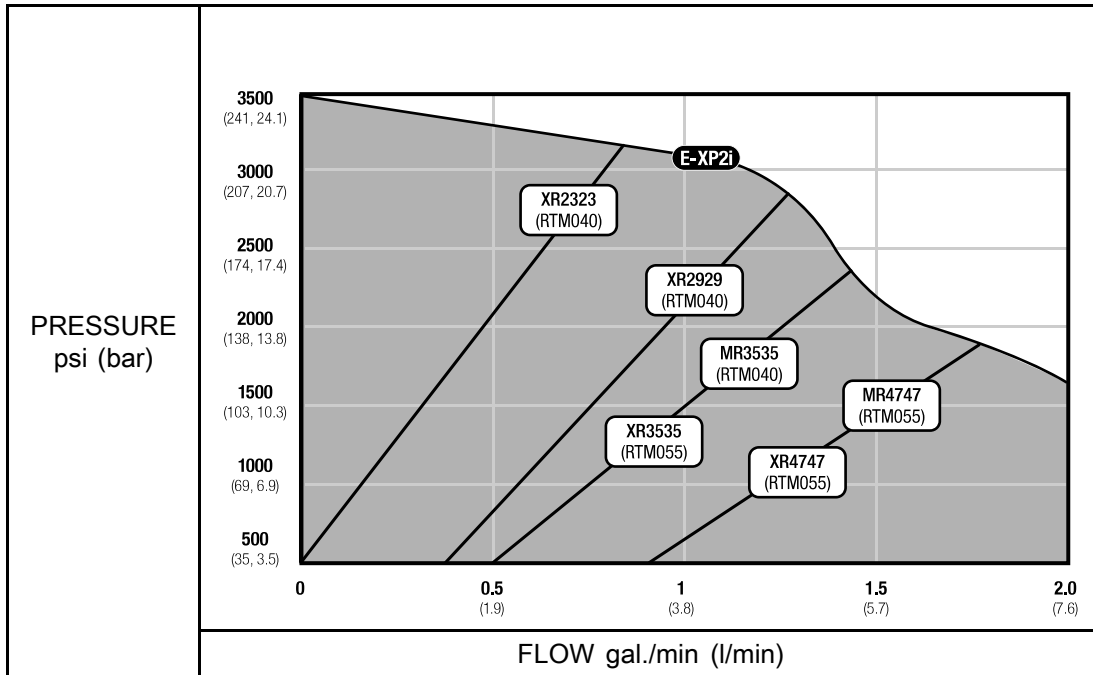
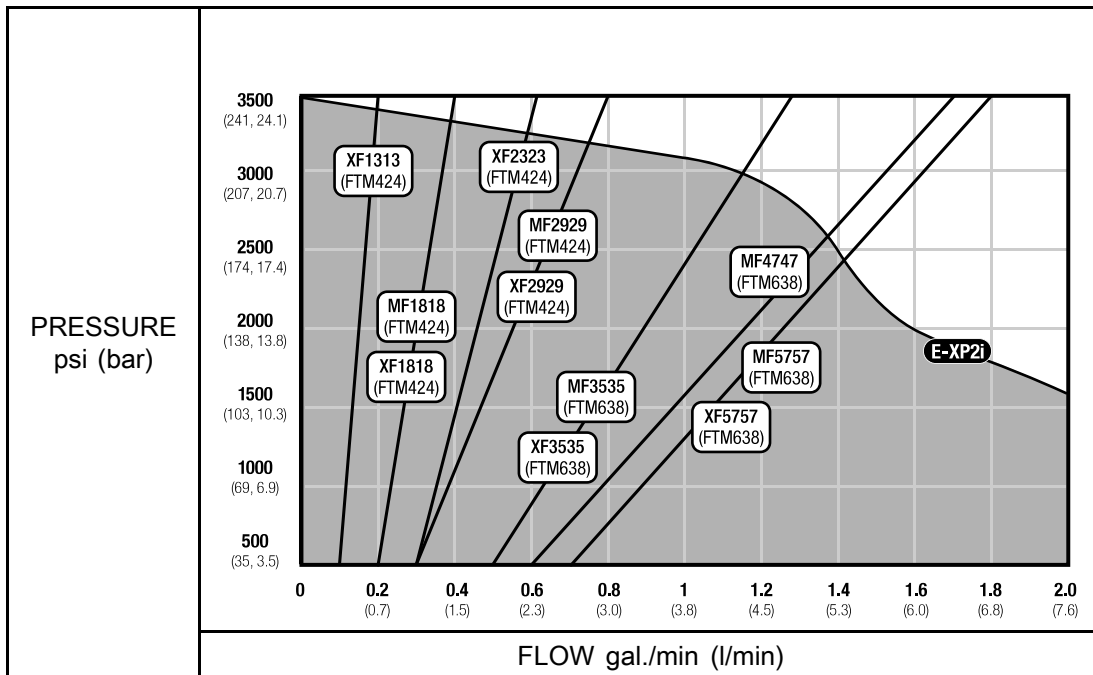

Table 7 Fusion Mechanical Purge, Flat Pattern



Technical Specifications

Reactor 2 Elite Integrated Proportioning Systems		
	U.S.	Metric
Maximum Fluid Working Pressure		
E-30i	2000 psi	14 MPa, 140 bar
E-XP2i	3500 psi	24.1 MPa, 241 bar
Maximum Fluid Temperature		
E-30i	150°F	65°C
E-30i with booster heater	180°F	82°C
E-XP2i	180°F	82°C
Maximum Output		
E-30i	30 lb/min	13.5 kg/min
E-XP2i	2 gpm	7.6 lpm
Maximum Heated Hose Length		
Length	310 ft	94 m
Output per Cycle, A and B		
E-30i	0.0272 gal.	0.1034 liter
E-XP2i	0.0203 gal.	0.0771 liter
Maximum Inlet Fluid Pressure		
E-30i and E-XP2i	300 psi	2.1 Mpa, 20.7 bar
Operating Ambient Temperature Range		
Temperature	20° to 120°F	-7° to 49°C
Auxiliary Power Available		
Voltage	120 Vac or 240 Vac, 60 Hz	
Engine		
Model	Perkins 404-22G, 2.2 L, 29 HP	
Alternator		
Model	Mecc Alte 22 kW, 240 V, 1 PH, 60 Hz, pancake style	
Battery Requirements		
Voltage	12 Vdc	
Minimum Cold Cranking Amps	800 CCA	
Connection Type	Post Style	

Reactor 2 Elite Integrated Proportioning Systems		
Recommended Battery Size		
BC Group Number	34	
Length	10.25 in.	260 mm
Width	6.81 in.	173 mm
Height	7.88 in.	200 mm
Booster Heater Power		
E-30i	None	
E-30i with booster heat	4000 Watts	
E-XP2i	4000 Watts	
Rotary Vane Air Compressor		
Hydrovane Model V04 (PURS type), continuous run		
Part No.	025CK10	
Pressure	140 psi	0.9 MPa, 9.6 bar
Specifications	16 cfm	
Required Features	Thermal overload switch, Safety Relief Valve	
Motor: Baldor		
Part No.	EL1410-CUS	
Specifications	5 HP, 1735 RPM, 240 V, 1 Phase, OPSB	
Required Features	C face, lift rings	
Refrigerated Air Dryer		
Hankison Model H1T20		
Specifications	115VAC, 1 Phase, 60 Hz, 22 scfm at 150 psi (1 MPa, 10.3 bar)	
Required Features	Pilot valve unloader	
Noise , Sound Pressure measured per ISO-9614-2.		
Sound Pressure measured from 3.1 ft (1 m), at 1500 psi (10 MPa, 103 bar), 2 gpm (7.6 lpm)	91.0 dBA	
Fluid Inlets		
Component A (ISO) and Component B (RES)	3/4 NPT(f) with 3/4 NPSM(f) union	
Fluid Outlets		
Component A (ISO)	#8 (1/2 in.) JIC, with #5 (5/16 in.) JIC adapter	
Component B (RES)	#10 (5/8 in.) JIC, with #6 (3/8 in.) JIC adapter	
Fluid Circulation Ports		

Technical Specifications

Reactor 2 Elite Integrated Proportioning Systems		
Size	1/4 NPSM(m), with sst braided tubing	
Maximum Pressure	250 psi	1.75 MPa, 17.5 bar
Weight		
E-30i	1750 lb	794 kg
E-30i with compressor and dryer	2200 lb	998 kg
E-30i with booster heat	1800 lb	816 kg
E-30i with booster heat, compressor, and dryer	2250 lb	1021 kg
E-XP2i	1800 lb	816 kg
E-XP2i with compressor and dryer	2200 lb	998 kg
Wetted Parts		
Material	Aluminum, stainless steel, zinc plated carbon steel, brass, carbide, chrome, chemically resistant o-rings, PTFE, ultra-high molecular weight polyethylene	

Graco Extended Warranty for Integrated Reactor® 2 Components

Graco warrants all equipment referenced in this document which is manufactured by Graco and bearing its name to be free from defects in material and workmanship on the date of sale to the original purchaser for use. With the exception of any special, extended, or limited warranty published by Graco, Graco will, for a period of twelve months from the date of sale, repair or replace any part of the equipment determined by Graco to be defective. This warranty applies only when the equipment is installed, operated and maintained in accordance with Graco's written recommendations.

Graco Part Number	Description	Warranty Period
24U050	Electric Motor	36 Months or 3 Million Cycles
24U051	Electric Motor	36 Months or 3 Million Cycles
24U831	Motor Control Module	36 Months or 3 Million Cycles
24U832	Motor Control Module	36 Months or 3 Million Cycles
24U855	Heater Control Module	36 Months or 3 Million Cycles
24U854	Advanced Display Module	36 Months or 3 Million Cycles
All other Reactor 2 parts		12 Months

This warranty does not cover, and Graco shall not be liable for general wear and tear, or any malfunction, damage or wear caused by faulty installation, misapplication, abrasion, corrosion, inadequate or improper maintenance, negligence, accident, tampering, or substitution of non-Graco component parts. Nor shall Graco be liable for malfunction, damage or wear caused by the incompatibility of Graco equipment with structures, accessories, equipment or materials not supplied by Graco, or the improper design, manufacture, installation, operation or maintenance of structures, accessories, equipment or materials not supplied by Graco.

This warranty is conditioned upon the prepaid return of the equipment claimed to be defective to an authorized Graco distributor for verification of the claimed defect. If the claimed defect is verified, Graco will repair or replace free of charge any defective parts. The equipment will be returned to the original purchaser transportation prepaid. If inspection of the equipment does not disclose any defect in material or workmanship, repairs will be made at a reasonable charge, which charges may include the costs of parts, labor, and transportation.

THIS WARRANTY IS EXCLUSIVE, AND IS IN LIEU OF ANY OTHER WARRANTIES, EXPRESS OR IMPLIED, INCLUDING BUT NOT LIMITED TO WARRANTY OF MERCHANTABILITY OR WARRANTY OF FITNESS FOR A PARTICULAR PURPOSE.

Graco's sole obligation and buyer's sole remedy for any breach of warranty shall be as set forth above. The buyer agrees that no other remedy (including, but not limited to, incidental or consequential damages for lost profits, lost sales, injury to person or property, or any other incidental or consequential loss) shall be available. Any action for breach of warranty hereunder must be brought within the latter of two (2) years of the date of sale, or one (1) year the warranty period expires.

GRACO MAKES NO WARRANTY, AND DISCLAIMS ALL IMPLIED WARRANTIES OF MERCHANTABILITY AND FITNESS FOR A PARTICULAR PURPOSE, IN CONNECTION WITH ACCESSORIES, EQUIPMENT, MATERIALS OR COMPONENTS SOLD BUT NOT MANUFACTURED BY GRACO. These items sold, but not manufactured by Graco (such as electric motors, switches, hose, etc.), are subject to the warranty, if any, of their manufacturer. Graco will provide purchaser with reasonable assistance in making any claim for breach of these warranties.

In no event will Graco be liable for indirect, incidental, special or consequential damages resulting from Graco supplying equipment hereunder, or the furnishing, performance, or use of any products or other goods sold hereto, whether due to a breach of contract, breach of warranty, the negligence of Graco, or otherwise.

FOR GRACO CANADA CUSTOMERS

The Parties acknowledge that they have required that the present document, as well as all documents, notices and legal proceedings entered into, given or instituted pursuant hereto or relating directly or indirectly hereto, be drawn up in English. Les parties reconnaissent avoir convenu que la rédaction du présente document sera en Anglais, ainsi que tous documents, avis et procédures judiciaires exécutés, donnés ou intentés, à la suite de ou en rapport, directement ou indirectement, avec les procédures concernées.

Graco Information

For the latest information about Graco products, visit www.graco.com.

To place an order, contact your Graco Distributor or call to identify the nearest distributor.

Phone: 612-623-6921 **or Toll Free:** 1-800-328-0211 **Fax:** 612-378-3505

All written and visual data contained in this document reflects the latest product information available at the time of publication.

Graco reserves the right to make changes at any time without notice.

For patent information, see www.graco.com/patents.

Original Instructions. This manual contains English. MM 332636

Graco Headquarters: Minneapolis

International Offices: Belgium, China, Japan, Korea

GRACO INC. AND SUBSIDIARIES • P.O. BOX 1441 • MINNEAPOLIS MN 55440-1441 • USA

Copyright 2014, Graco Inc. All Graco manufacturing locations are registered to ISO 9001.

www.graco.com

Revision G, January 2016